

Manufacturer of protection systems for construction sites

Temporary stairs, platforms, fences and barriers





We are Swedish-Polish group specialising in the design and production of solutions for the industrial and construction sectors.

We are able to predict the challenges in the next stages of construction and industrial project.

Keep calm due to our experience.

20 000+ m² of production space in three automated facilities

2005 the year we started

15 branches throughout Europe

50+ countries where our projects are located

Manufacturer, TLC Sp. z o.o., holds Enviromental Product Declaration in acc. with ISO 14025:2006 and EN 15804:2012+A2:2019/AC:2021 for industrial communication systems including stairs, railings and fencings.



TLC's production plant has implemented Factory Production Control according to EN 1090-1 and welding quality system according to PN-EN ISO 3834-2, both certified by TUV SUD Polska.

TLC's production plant has been certified with the Integrated Management System of Quality, Environment and OHS (ISO 9001/ ISO 14001/ ISO 45001) issued by Bureau Veritas Certification.



The information contained in this advertising material is provided for informational purposes only.

The product specification should be checked against the technical documentation provided by the manufacturer.



TLC	2
Mobilt temporary mesh fences	4 - 5
Smart temporary hoarding fences	6 - 7
City security barriers	8 - 9
TUP unloading platform	10 - 11
TAS temporary stairs	12 - 13
TAS temporary staircases	14 - 15
SST temporary spiral staircase	16 - 17
EPS edge protection system	18 - 19
Stairs for containers	20 - 21
Our potential	22 - 23

Mobilt

temporary
mesh fences

The Mobilt system consists of galvanized mesh panels, an accessories system and stabilizing feet.

It is utilized in areas undergoing construction or roadwork, where hoarding fences are unnecessary.



easy assembly
and disassembly



solid and durable
construction



a wide range of fence
types and accessories



great protection
of construction sites



anti-corrosion by
galvanization



check out the full range
of our Mobilt fences



Mobilt

Mobilt S

Mobilt CB

Mobilt PRO



Mobilt HDG-3

Mobilt RC

Mobilt RC CB

Mobilt RC-CBS



Mobilt Anti-Climb

Mobilt RC-S Anit-Climb

Mobilt H-RC

Mobilt H

Additional reinforcement

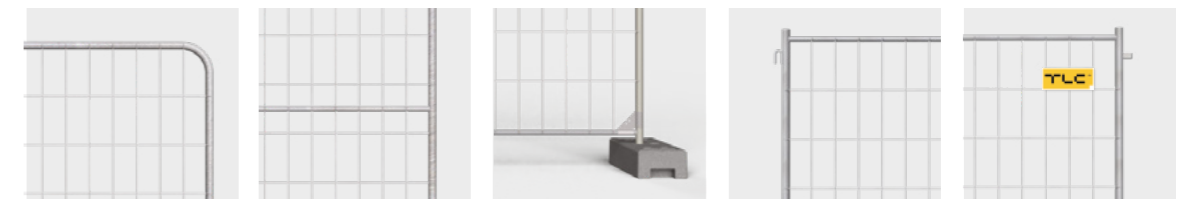

Round corner RC

Horizontal pipe S

Corner
reinforcement CB

Hook

Eye

Panel type	Index	Dimensions [mm]	Weight [kg]	Additional Reinforcement	Mesh eye [mm]	Wire diameter [mm]
Mobilt	OT-MOB-M1	3430 × 2000	12	no	120 × 250	3,0
Mobilt S	OT-MOB-M2	3430 × 2000	14,1	additional horizontal pipe	120 × 250	3,0
Mobilt CB	OT-MOB-M3	3430 × 2000	12,3	corner reinforcement	120 × 250	3,0
Mobilt PRO	OT-MOB-P1	3430 × 2000	15,2	no	120 × 250	3,0 × 4,0
Mobilt HDG-3	OT-MOB-HDG1	3430 × 2000	15,7	no	120 × 250	3,0
Mobilt RC	OT-MOB-RC1	3430 × 2000	13	no	120 × 250	3,0
Mobilt RC-CB	OT-MOB-RC3	3430 × 2000	13,1	corner reinforcement	120 × 250	3,0
Mobilt RC-CBS	OT-MOB-RC4	3430 × 2000	15,2	corner reinforcement, additional horizontal pipe	120 × 250	3,0
Mobilt Anti-Climb	OT-MOB-M6	3430 × 2000	15,8	no	40 × 250	3,0
Mobilt RC-S Anit-Climb	OT-MOB-RC8	3430 × 2000	20	additional horizontal pipe	40 × 250	3,0
Mobilt H-RC	OT-MOB-H2	3430 × 1200	9,4	no	120 × 250	3,0
MOBILT H	OT-MOB-H1	3430 × 1200	8,6	no	120 × 250	3,0

Smart

temporary
hoarding fences

The Smart system is recommended for fencing construction sites and industrial areas.

The system panels consist of a solid, zinc-coated steel frame filled with T18 trapezoidal sheet metal, which can be additionally covered with a layer of varnish.

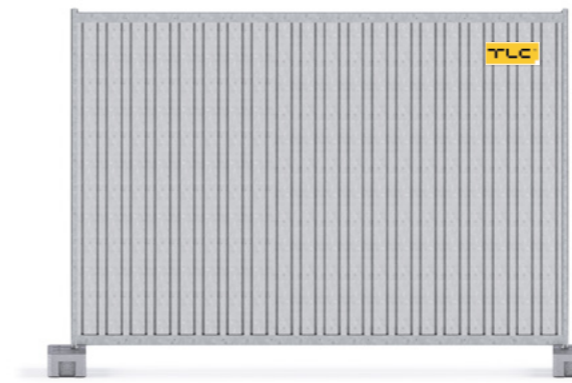

Smart Light galvanized panel



Smart RAL-painted panel

	Galvanized panel		Painted panel	
	Smart	Smart Light	Smart	Smart Light
Panel type	Smart	Smart Light	Smart	Smart Light
Weight [kg]	35,5	31,5	38	34
Dimensions [mm]	2825 × 2080	2825 × 2080	2825 × 2080	2825 × 2080
Frame construction	steel tube 42,4 × 2 mm angle bars 60 × 40 × 2 mm	steel tube 42,4 × 1,5 mm angle bars 60 × 40 × 1,5 mm	steel tube 42,4 × 2 mm angle bars 60 × 40 × 2 mm	steel tube 42,4 × 1,5 mm angle bars 60 × 40 × 1,5 mm
Filling	trapezoidal T18 galvanized sheet	trapezoidal T18 galvanized sheet	trapezoidal T18 RAL sheet	trapezoidal T18 RAL sheet



easy assembly
and disassembly



solid and durable
construction



a wide range of fence
types and accessories



great protection of
construction sites
in the city center



panels available
in four versions -
Galvanized, Galvanized Light,
RAL, RAL Light



check out the full range
of our Smart fences

Accessories

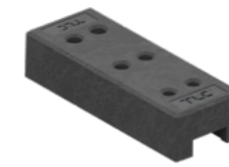

PVC foot



Concrete foot



Anti lift device



Steel anchor



Special anchor



Pin



Gate wheel



Hinge standard



Pedestrian gate hinge



Clamp



Smart vehicle gate



Smart pedestrian gate



P-1 support



P-2 support

City

security barriers

City portable barriers are designed for temporary fencing of areas during sporting events and concerts. They are used to fence off routes and temporary communication routes.



easy assembly and disassembly



excellent for delineating communication pathways



no additional loads required for installation



available in standard and light versions



check out the full range of our City barriers

City Standard

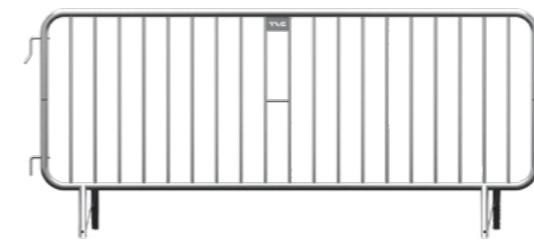

City Light

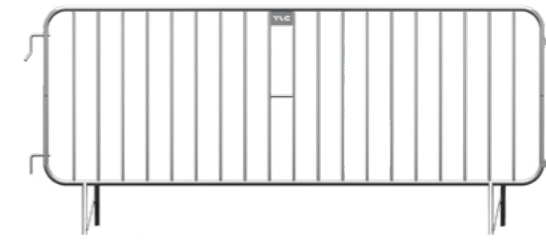

Standard feet

Barrier type	Index	Dimensions [mm]	Additional Reinforcement	Design [mm]	Filling [mm]	Weight [kg]
City Standard	P-OT-CSG	2600 × 1100	hot-dip galvanizing	steel tubes 38×1,5	pipes 16	20
City Light	P-OT-CLG	2600 × 1100	hot-dip galvanizing	steel tubes 25×1,5	pipes 14	13

City Standard W



Exchangeable flat feet

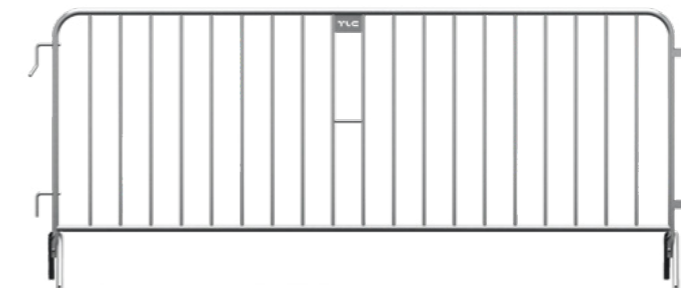

Exchangeable V-feet

Barrier type	Index	Dimensions [mm]	Additional Reinforcement	Design [mm]	Filling [mm]	Weight [kg]
City Standard W	P-OT-CSW	2600 × 1100	hot-dip galvanizing	steel tubes 38×1,5	pipes 16	19,4

City Light W



Exchangeable flat feet

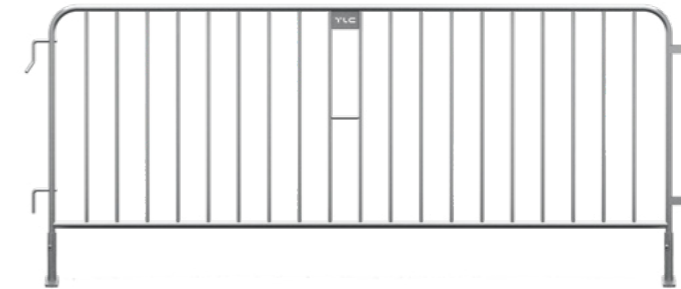

Exchangeable V-feet

Barrier type	Index	Dimensions [mm]	Additional Reinforcement	Design [mm]	Filling [mm]	Weight [kg]
City Light W	P-OT-CLW	2600 × 1100	hot-dip galvanizing	steel tubes 25×1,5	pipes 14	12,9

City Green



Standard feet

Barrier type	Index	Dimensions [mm]	Additional Reinforcement	Design [mm]	Filling [mm]	Weight [kg]
City Green	P-OT-CGR-2,3	2260 × 1125	galvanized steel	steel tubes 28×1	pipes 14	9,5

TUP

unloading platform

The TUP unloading platform is designed to enhance safety and streamline the transportation of materials to various floors within a building.

Equipped with special handles for lifting and for securing safety harnesses, the platform ensures secure handling. The ability to assemble and disassemble individual components significantly enhances the platform's mobility while reducing transportation costs.



allowed platform workload: 4000 kg



compliance with the standard PN-EN 12811



mobility - easy assembly, disassembly and low transport costs



3 available widths: (1.25 m, 1.5 m i 2.2 m)



anti-corrosive protection through hot-dip galvanization and powder painting



enables fast transport and unloading of materials

Available assembly methods:

Between building tiers

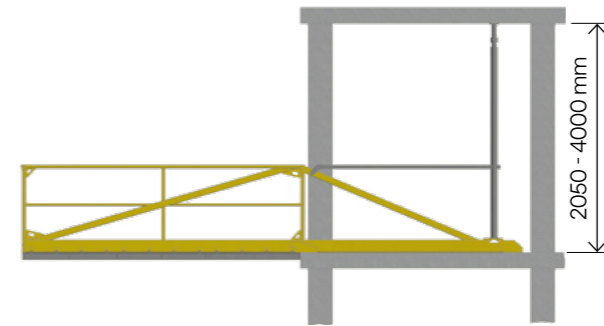

By anchoring to the slab

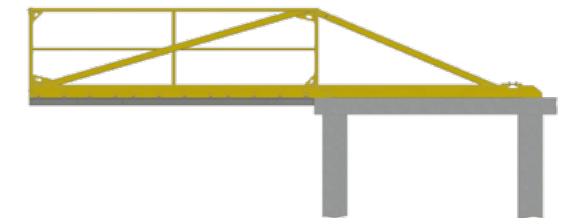

Dimensions of the platform, unloading surface and supports:

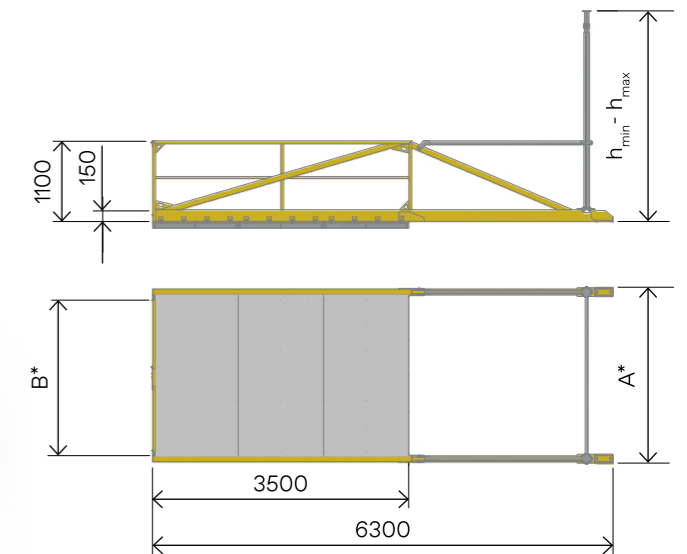

*A and B widths for particular variants available in the table below

$h_{min} = 2800\text{mm}$, $h_{max} = 4000\text{mm}$ with support Peri PEP Ergo D-400.

Article no.	TUP-1.25	TUP-1.5	TUP-2.2
Weight [kg]	751 without supports 814 with supports	810 without supports 863 with supports	960 without supports 1013 with supports
Platform width [A]	1456	1706	2403
Unloading area width [B]	1250	1500	2200
Intended use	the platform functions as a finished solution ensuring proper unloading area for materials transported using cranes and other lifting equipment		
Materials	S235/S355 steel, aluminum	S235/S355 steel, aluminum	S235/S355 steel, aluminum

TAS

temporary stairs

The TAS system is a multifunctional structure that can be quickly and easily configured to meet various needs, serving as:

- temporary stairs for overcoming both small and significant level differences of various inclines
- temporary gangways
- step-over platforms for navigating small obstacles
- scaffolding stairs - TAS stairs equipped with special clamps enable assembly on scaffold systems



ability to create many configurations - stairs, gangways, step-over platforms etc.



compliance with the standard PN-EN 12811



anti-slip steps available in two widths: 700 and 1000 mm



easy assembly and disassembly



check out the full range of our TAS stairs

Distributed load

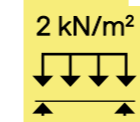

Point of load

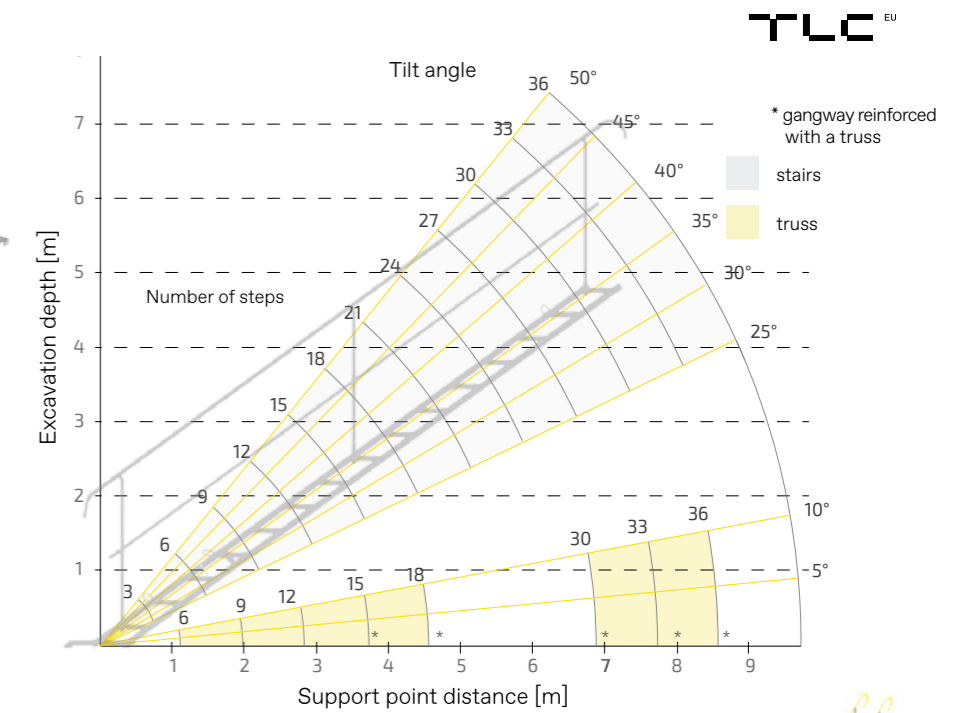
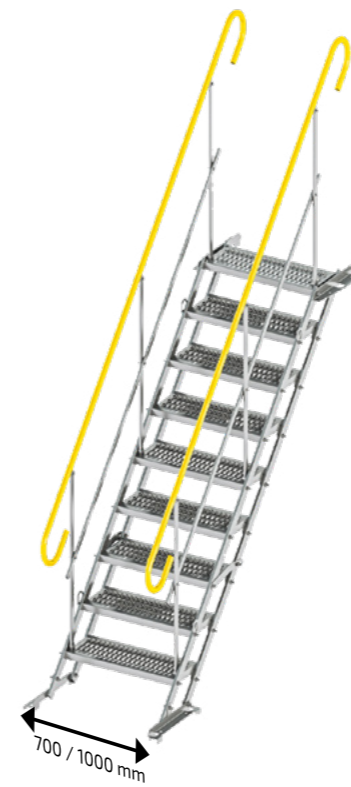

Number of steps	3		6		9		12		15		18	
Width [m]	700	1000	700	1000	700	1000	700	1000	700	1000	700	1000
Height [m]	0 - 0,6		0 - 1,2		0 - 1,8		0 - 2,4		1,6 - 3,0		2,1 - 3,6	
Weight [kg]*	47	56	74	93	105	134	133	171	162	208	192	248
Flight length [m]	0,8		1,61		2,24		3,23		4,05		4,86	
Length of stairs with guardrails [m]	1,4		2,2		3		3,8		4,6		5,4	
Max. number of users on the stairs	1		1		2		2		2		3	
Possibility to use as a gangway	no		yes		yes		yes		yes (when used with a truss)		yes (when used with a truss)	
Trench width [m]	-		1,17		1,98		2,78		4,60		4,40	

The table above shows the basic parameters of the available modules
* weight includes stairs and two guardrails

Additional elements



Accessories

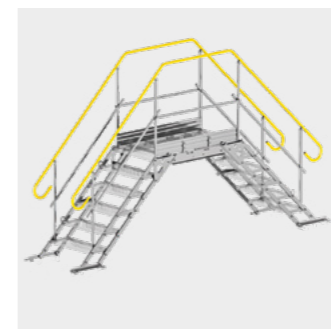

Step-over platform

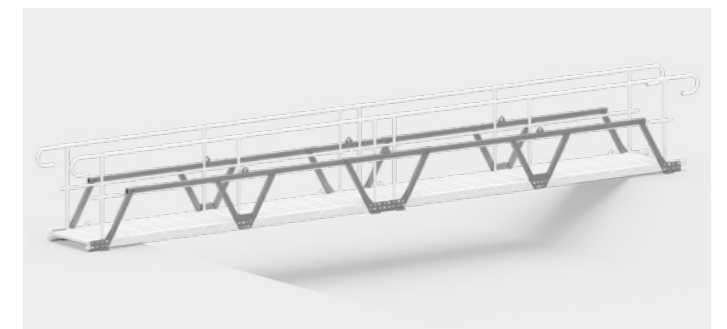

Gangway and truss

TAS

temporary staircases

Our staircases feature a modular design, offering remarkable flexibility in achieving various heights and descent directions.

The system comprises two modules: LOWER and STANDARD, along with temporary stairs.

The STANDARD module always includes a set of 12-step stairs, whereas the LOWER module allows for the selection of the appropriate number of steps based on the desired module height.



↑ 9,9 m

max. height 9,9 m
(4 modules)



compliance with
the standard
PN-EN 12811



anti-slip steps



easy assembly
and disassembly



check out the full range
of our TAS staircases

The TAS staircase descent is designed to eliminate level differences and distances between the staircase and the desired level.

The staircase features height adjustment with 7 positions (every 195 mm). To eliminate level differences and distances between the staircase and the desired level extra TAS stairs (3 or 6 steps) can be attached to the staircase exit using special adapter. By utilizing extra TAS stairs, we gain the ability to smoothly adjust the exit level.

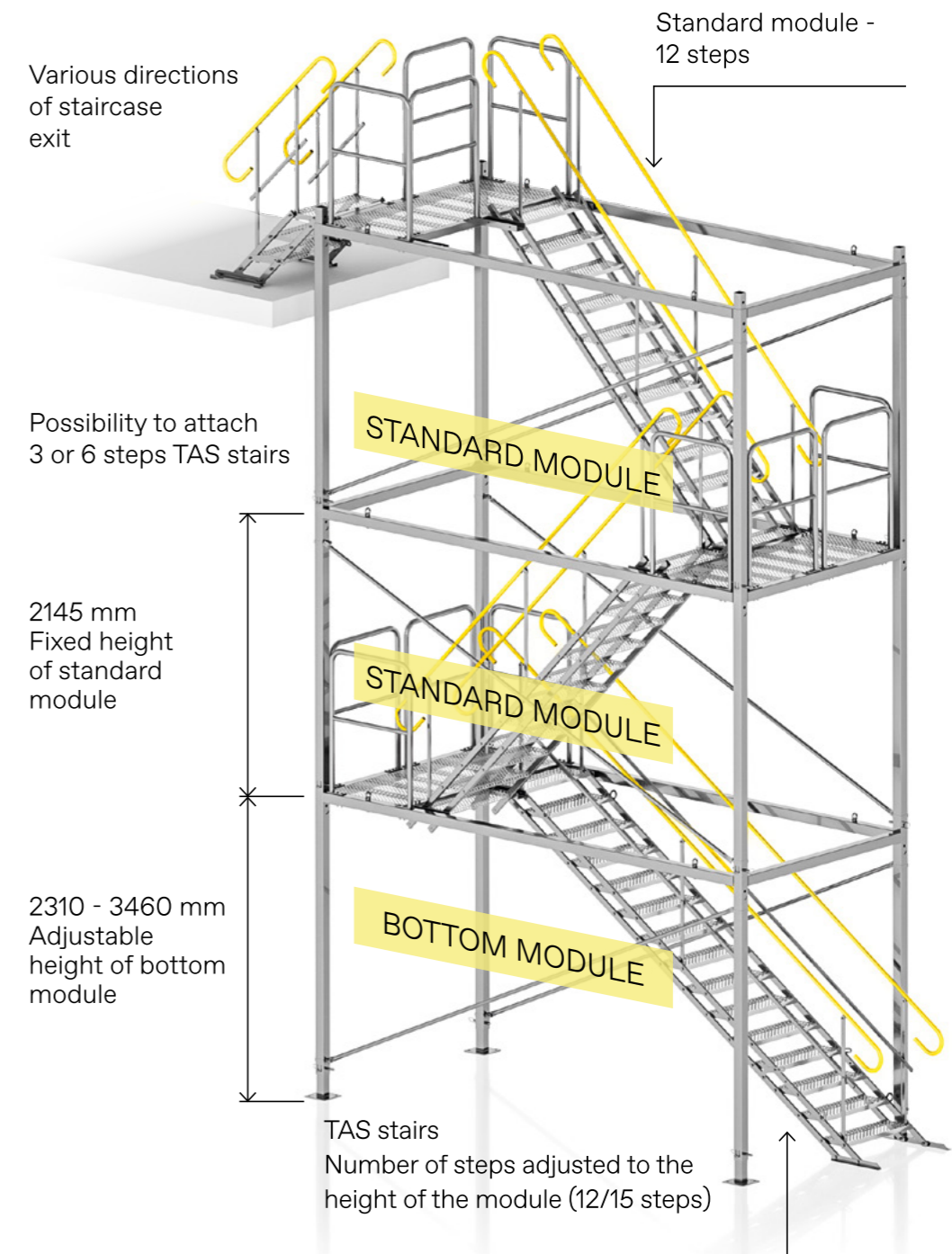

SST

temporary spiral staircase

Stairs are used on construction sites to facilitate communication between different levels.

The system comprises a base frame, intermediate module, exit step, or exit landing.

The construction is protected by hot-dip galvanization and is designed according to PN EN 12811 standard.



modular construction allowing the product customization for your needs



Possibility of compilation up to 8 modules (18440 mm)

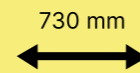

usable widths of stairs and landings – 730 mm



assembly based on screw connections



anchoring stairs to the structure using stabilizing consoles



compliance with the standard PN-EN 12811

Acceptable load unfolded



Acceptable load focused

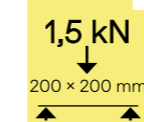

1 MODULE
2480 mm (min H)



8 MODULES
18440 mm (max H)

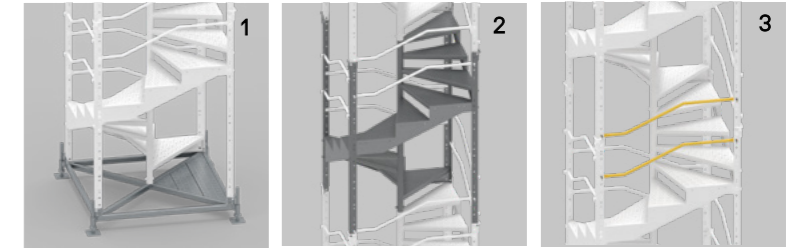
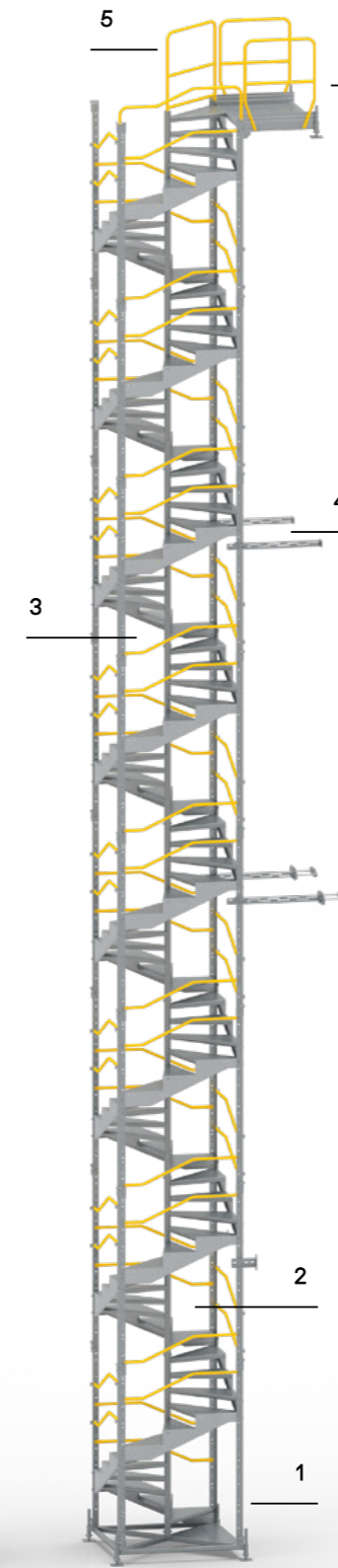

Base frame

Intermediate module (H 2280 mm)

Barrier

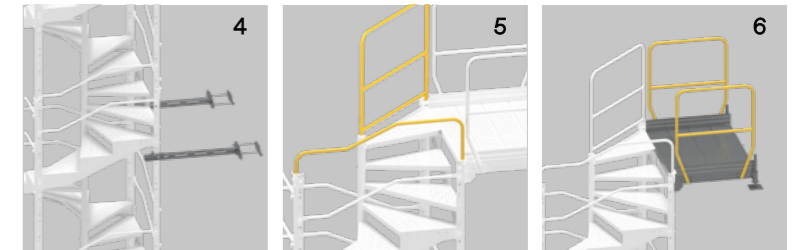

Stabilising consoles

Top module barrier

Exit landing

OPTIONAL SOLUTIONS

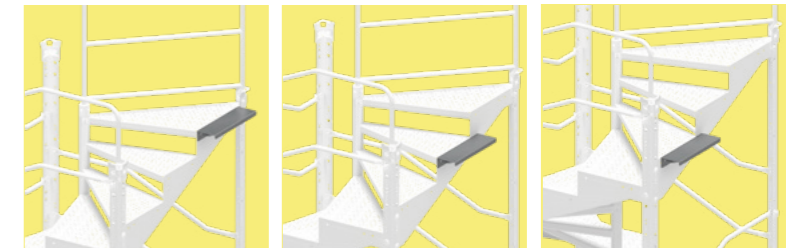

Exit step

Alternative options for mounting a exit step



Optional toe board

Optional assembly of another exit platforms



Additional level adjustment options for stair exit using TAS steps. Mounting of a platform without slab support with the possibility of lateral exit

Module	1	2	3	4	5	6	7	8
Height [mm]	2480	4760	7040	9320	11600	13880	16160	18440
Width [mm]	1600	1600	1600	1600	1600	1600	1600	1600
Weight [kg]	307	534	761	987	1214	1441	1667	1894

EPS

edge protection system

Our Edge Protection System is a contemporary fall protection system meticulously crafted to safeguard building and construction edges, technological openings (such as elevators), roof edges, passageways, and other areas prone to height-related risks.

The acronym EPS originates from Edge Protection System, encompassing a comprehensive array of safety solutions.



one pole compatible with all holders



wide range accessories



compliance with the standard PN EN 13374:2013



galvanized and painted powder coated panel

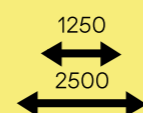

available lengths mesh panels: 1250, 2500 mm



check out the full range of our EPS system

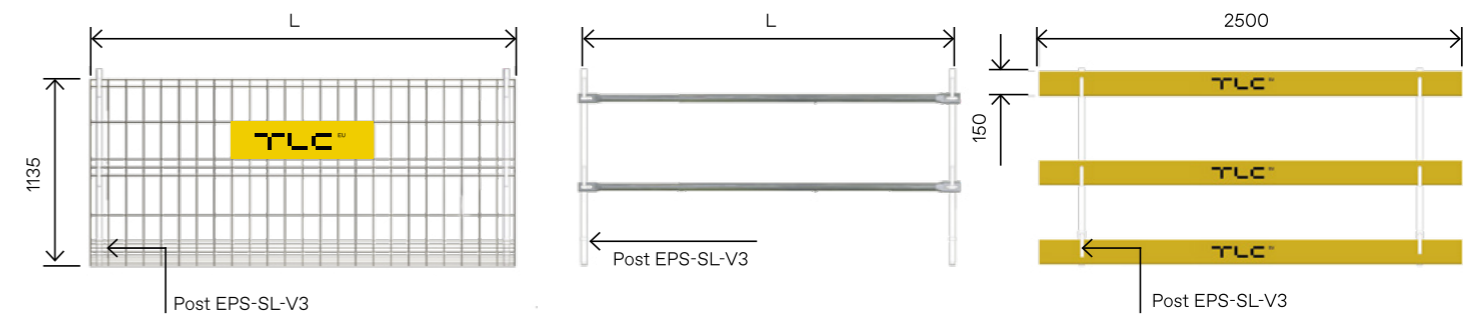

Version [mm]	2500	1250
Weight [kg]	12,4	6,2
Wire diameter [mm]	6	6
Index	EPS-PAN-ECO	EPS-PAN-ECO3-H

Version [mm]	500	700	1050	1750
Weight [kg]	1,9	2,8	5,3	8,9
Range [mm]	500-700	700-1050	1050-1750	1750-3000
Index	EPS-R500	EPS-R700	EPS-R1050	EPS-R1750

Weight [kg]	6,5
Plank thickness [mm]	32
Index	EPS-D



System post
EPS-SL-V3
3,7 kg



Post extension
EPS-PRS
1,4 kg



Horizontal screw-fastened
holder EPS-UPZ-V2
1,3 kg



Vertical screw-fastened
holder EPS-UPN-V2
1,5 kg



Girder holder
EPS-UDZ-V2
3,4 kg



Holder for steel structure
EPS-UG-V2
2,6 kg



Latching holder
EPS-UZT-V2
1,7 kg



Clamping holder L500
EPS-UUN-V2
5,5 kg



Clamping holder L800
EPS-UUN800-V2
8,5 kg



Stair holder
EPS-UUN-V4
7 kg



Bracket clamp with post
EPS-UUS
7,2 kg



Horizontal permanent
holder EPS-UZH-V2
0,1 kg



Vertical permanent
holder EPS-UZV-V2
0,2 kg



Drop-in holder
EPS-UW-V3
2,4 kg



Plank lower holder
EPS-UDS
0,3 kg



Working platform holder
EPS-UPR
1,8 kg



Wall holder
EPS-US
0,3 kg



Formwork girder
EPS-USZ
14,2 kg



Facade holder
EPS-USP
3,9 kg



Steel foot
EPS-PU
4,8 kg

Stairs for containers

Our stairs for containers are versatile, suitable for various types of construction containers, whether utilized for social areas, offices, warehouses, or shipping containers. Their lightweight and modular design ensures quick and easy installation.

Our stairs are designed in accordance with EN ISO 14122-3 and EN 12811-1.

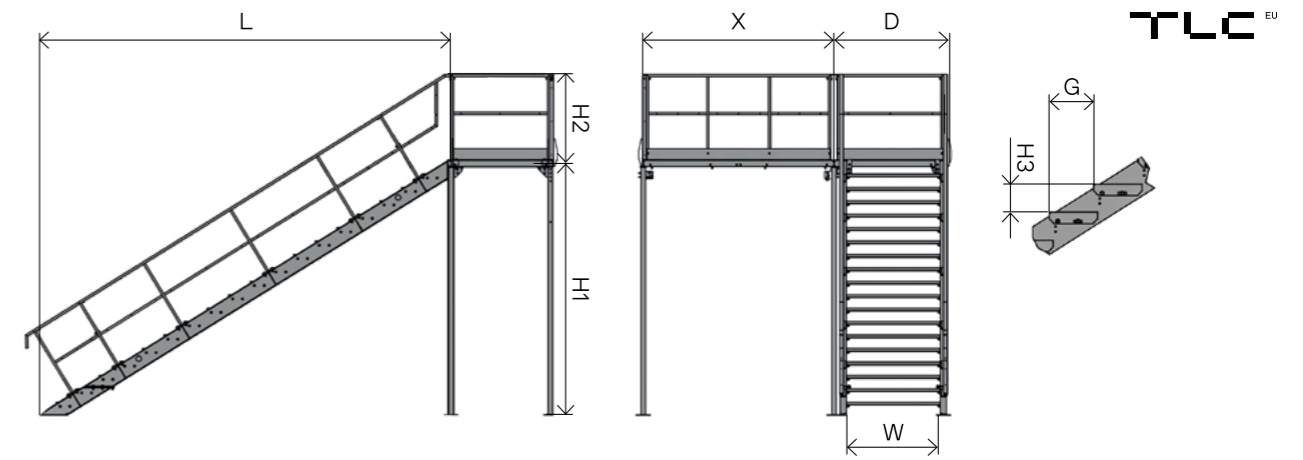

TLC^{EU}

	Container height [mm]	L [mm]	H [mm]	W [mm]	D [mm]	H2 [mm]	X [mm]	G [mm]	H3 [mm]	Number of steps
Steel stairs 2 kN	2960	4594	3060	1000 or 1250	1100 or 1250	1100	2440 or 3000	270	179	17
	2800	4324	2888							16
	2590	4037	2702							15
Steel stairs 5 kN	2960	4974	3060	1200	1440	1100	2440	280,4	171,8	18
	2800	4712	2900							17
	Aluminum stairs 2 kN	2960	4488							3055
2800	4245	2889	16							
2590	3953	2690	15							

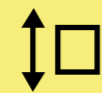

stairs adapted to container heights: 2960, 2800, 2590 mm

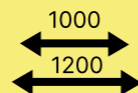

available widths: 1000, 1200 mm



compliance with standards
PN-EN ISO 14122-3,
PN-EN 12811



many configurations of steel and aluminum stairs



2kN, 5kN (steel stairs)
2kN (aluminum stairs)



check out the full range of our container stairs

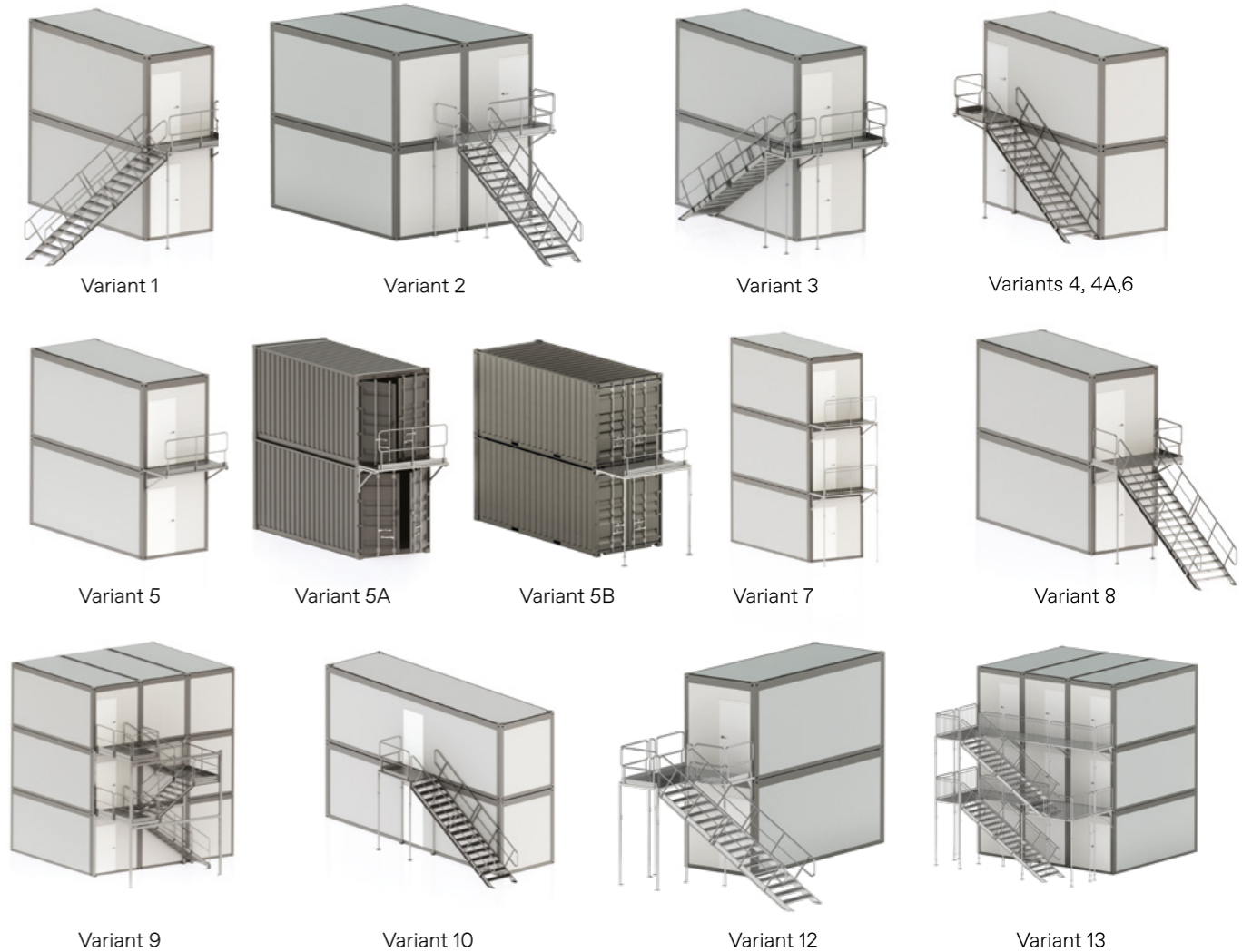

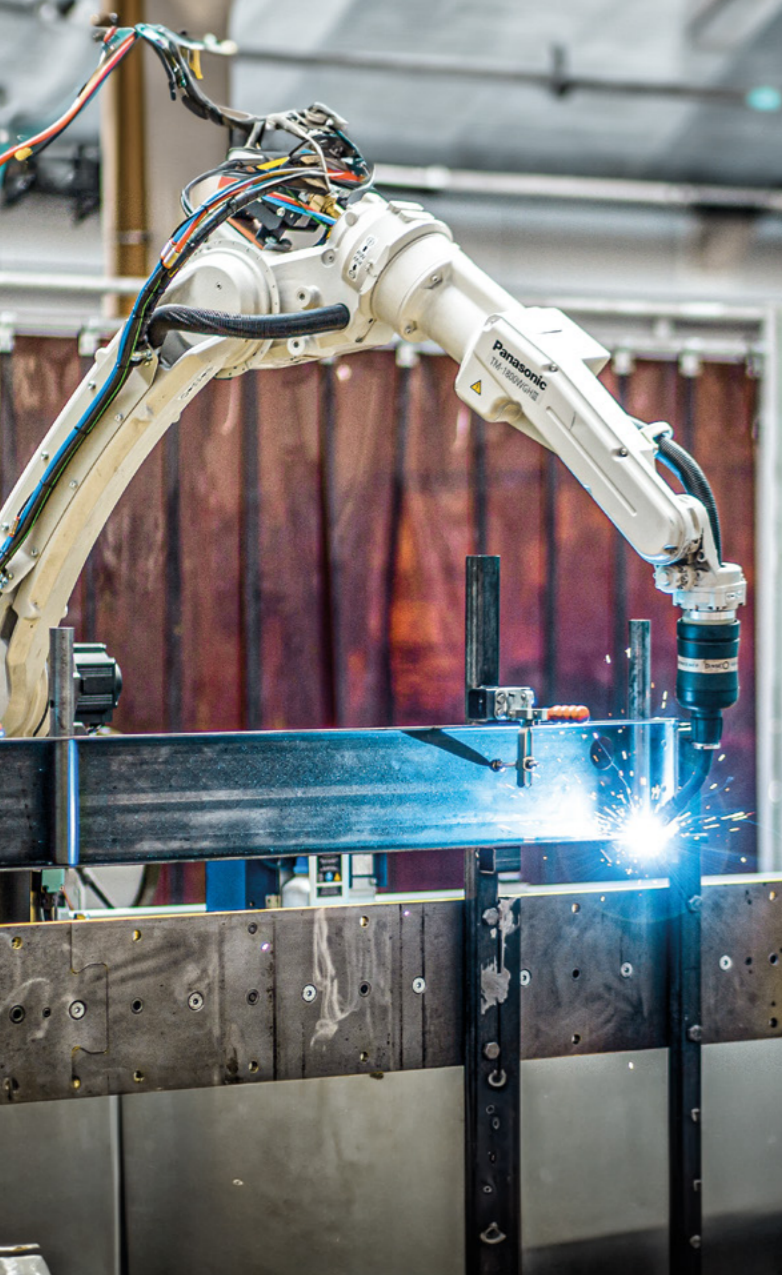

Selected machines:

- Welding robots - MAG welding
- Lasers - cutting profiles, pipes and sheets
- Technological lines for galvanizing and for powder coating
- Plasma - sheets cutting
- CNC pipe bender
- CNC press brake
- Automatic Multi-spot welder for openwork



We care for life:

The above points are only a small percentage of all pro-ecological activities that have been successfully implemented **since 2018**. They result in real benefits such as:

- Competitive prices of manufactured products - **over 50% of the energy comes from the sun**
- Reduced CO2 emissions
- Reduced energy costs
- Minimized amounts of harmful waste



replacement of 100%
of the car fleet by electric
and hybrid



power from
photovoltaic panels



automatic light
system, heat
pump system



electronic circulation
of invoices



gadgets and marketing
materials made
of recycled plastics

The combination of Swedish technology and Polish entrepreneurship has allowed us to specialise in the design and production of solutions for the industrial and construction sectors.

POLAND

TLC Sp. z o.o.

+48 505 140 140
info@tlc.eu
tlc.eu

SWEDEN

Inter TLC AB

+46 70 525 99 18
info@intertlc.se
intertlc.se

GERMANY

Inter TLC GmbH

+49 5147 709 00 72
info@intertlc.de
intertlc.de

FRANCE

Inter TLC SAS

+33 6 78 93 84 61
info@intertlc.fr
intertlc.fr

We started in 2005 as a small company and today we are a group of companies with projects all over the world. The thousands of projects we have completed confirm that we are a trusted business partner. Our key customers include leading companies in the construction and industrial sectors.

We are committed to green solutions and sustainability in our operations.

Visit our website:
TLC.EU

