

Stairs, platforms and staircases for containers





We are Swedish-Polish group specialising in the design and production of solutions for the industrial and construction sectors.

We are able to predict the challenges in the next stages of construction and industrial project.

Keep calm due to our experience.

20 000+ m² of production space in three automated facilities

2005 the year we started

15 branches throughout Europe

50+ countries where our projects are located

Manufacturer, TLC Sp. z o.o., holds Enviromental Product Declaration in acc. with ISO 14025:2006 and EN 15804:2012+A2:2019/AC:2021 for industrial communication systems including stairs, railings and fencings.



TLC's production plant has implemented Factory Production Control according to EN 1090-1 and welding quality system according to PN-EN ISO 3834-2, both certified by TUV SUD Polska.

TLC's production plant has been certified with the Integrated Managment System of Quality, Environment and OHS (ISO 9001/ ISO 14001/ ISO 45001) issued by Bureau Veritas Certification.



The information contained in this advertising material is provided for informational purposes only.

The product specification should be checked aganist the technical documentation provided by the manufacturer.

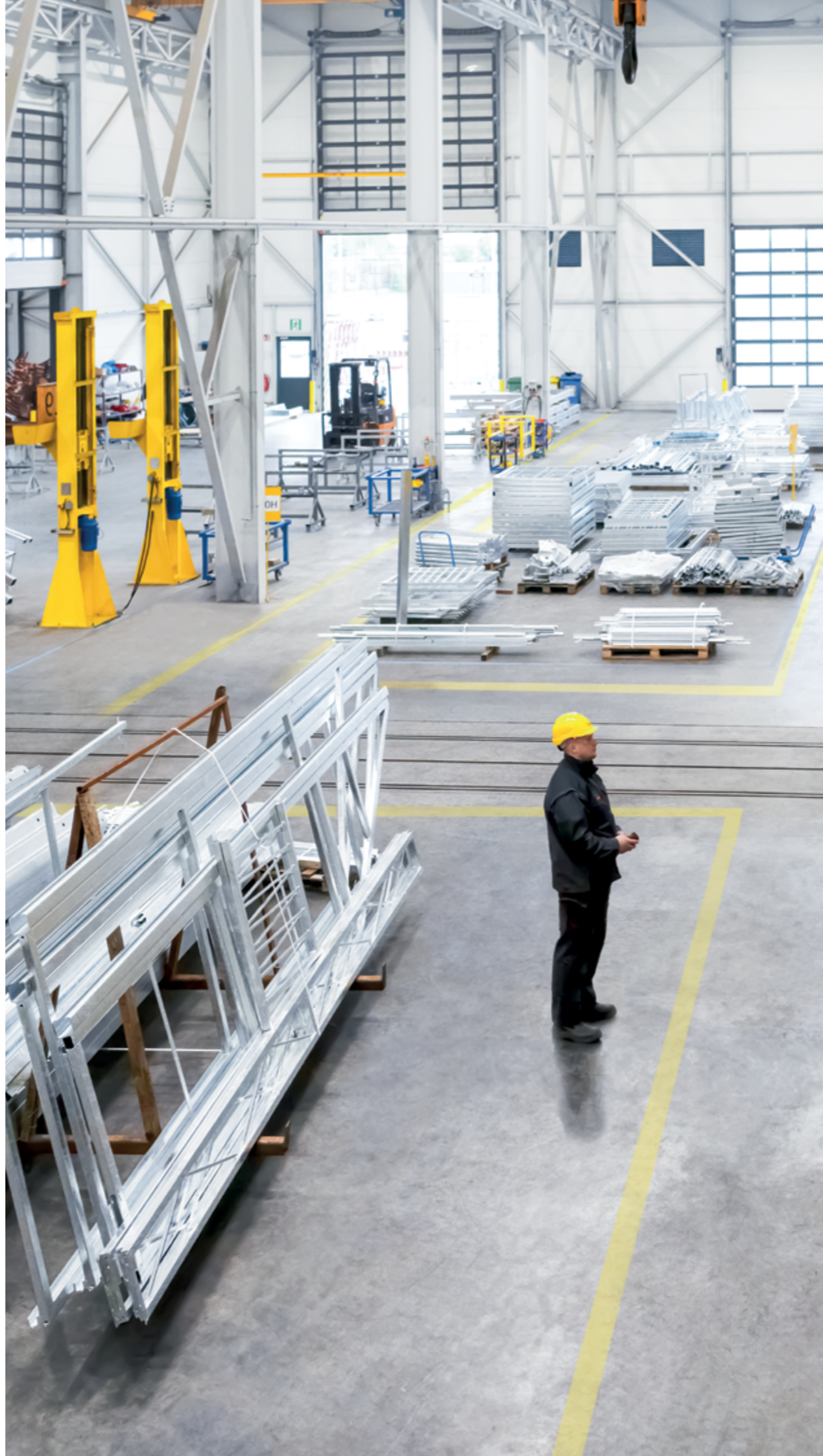

TLC	2
Stairs, platforms and staircases for containers	4 - 5
Steel stairs 2kN	6 - 9
Steel stairs 5kN	10 - 13
Aluminum stairs 2kN	14 - 17
Staircases	18 - 21
Accessories & additional solutions	22 - 23
Terraces	24 - 25
Our realisations	26 - 29
Our potential	30 - 31

Stairs, platforms and staircases for containers

General informations

TLC container stairs are universal, durable and easy to assemble light modular structures designed and manufactured in accordance with industry standards. Attention to every detail from project, through production, endurance tests and quality control makes our product reliable even in the most demanding conditions. Thanks to that TLC container stairs provide hassle-free and safe usage through many years.

Standard features of available solutions:

- Safe stairs system designed in accordance to EN ISO 14122-3 and EN 12811-1
- Maximum workloads: 2kN/m² and 5kN/m², depending on version
- Various widths of steps: 1000 mm and 1250 mm (2kN/m² version) and 1200 mm (5kN/m² version)
- The system is compatible with both office and shipping/storage containers
- Static calculations based on eurocodes
- Steps and platforms with non-slippery surface (R12)
- Modular system that enables to easy and space-saving transport, short assembly process, and wide configuration variety depending on container sizes and available space
- Easy to assemble and disassemble without losing its performance values
- Durability and resistance to weather conditions thanks to hot-dip galvanizing
- Available in two versions: steel and aluminum
- Wide range of accessories and solutions (staircases, roofs and coverings, ramps for the disabled, balconies, steps to sewage tanks, frames for solar panels, terraces)



Steel stairs 2kN

A type of steel stairs often used as a temporary solution, intended for long-term rental.



Technical details

- Steps and platforms with non slippery surface (R12)
- Two widths of steps: 1000 and 1250 mm
- Fast and simple assembly in any configuration
- Repeatability of elements, extension possibility
- Container stairs 2kN designed according to the DGUV recommendations for Germany
- Container stairs 2kN designed according to the BFU recommendations for Switzerland

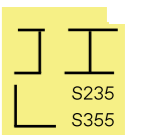
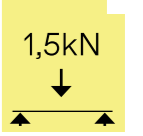
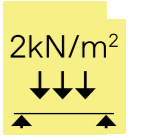

Types of balustrades

- **Industrial balustrade**

Light and simple construction that can be used whenever children safe railings are not required by law.



- **Safe balustrade**

The railing is filled with additional bars according to imposed standards. They are used at areas where rigorous safety norms are in force.

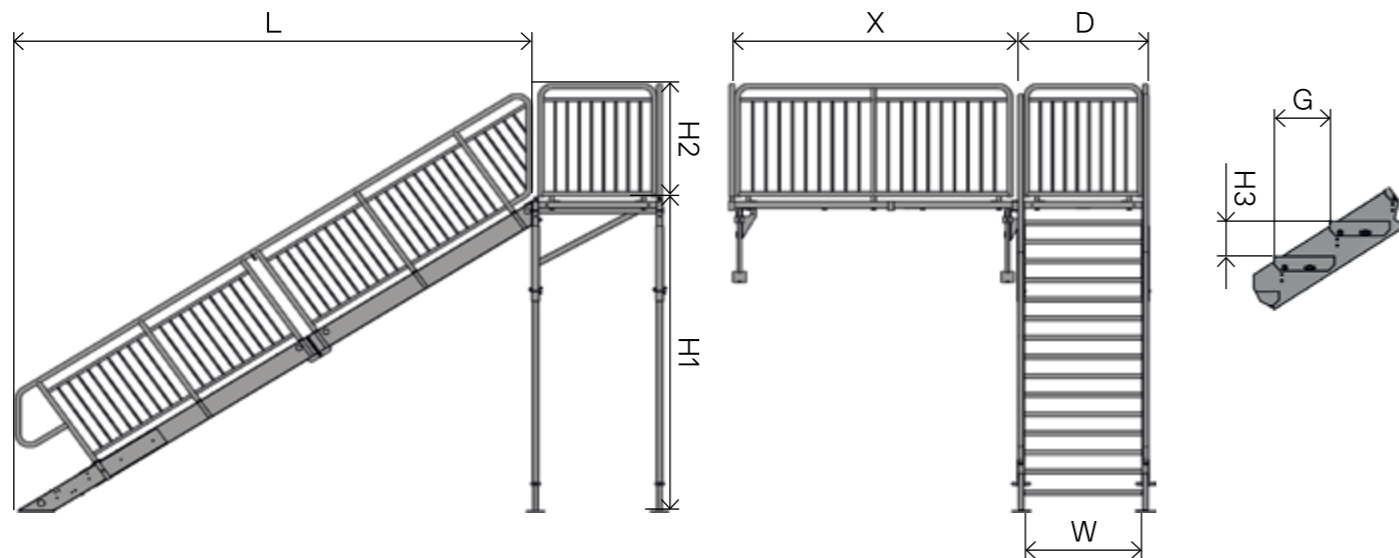

Steel stairs 2kN									
Container height [mm]	L [mm]	H1 [mm]	W [mm]	D [mm]	H2 [mm]	X [mm]	G [mm]	H3 [mm]	Number of steps
2960	4594	3060	1000 or 1250	1100 or 1250	1100	2440 or 3000	270	179	17
2800	4324	2888							16
2590	4037	2702							15

Assembly variants

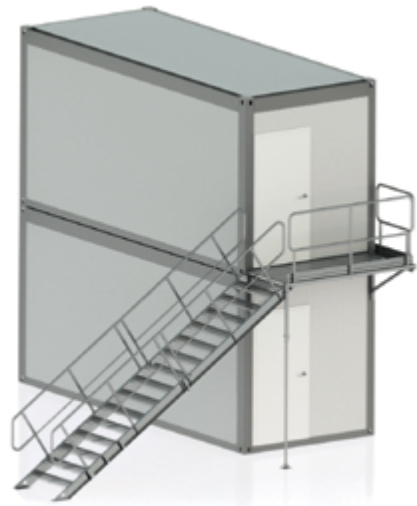

variant S2.1



variant S2.3

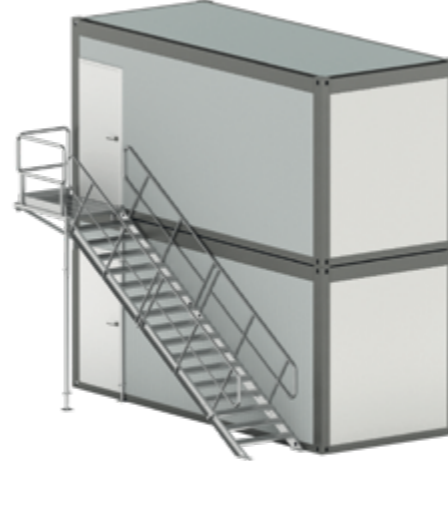

variants S2.4, S2.4A, S2.6

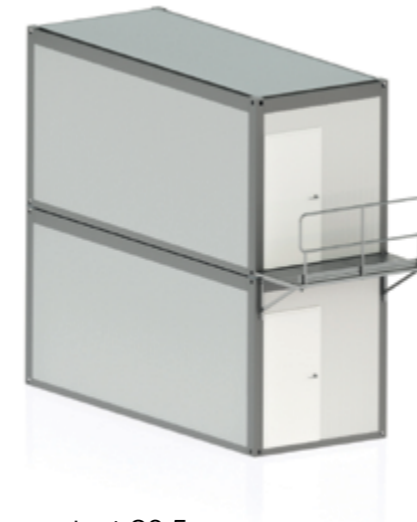

variant S2.5



variants S2.5A, S2.5B



variant S2.7



variant S2.8

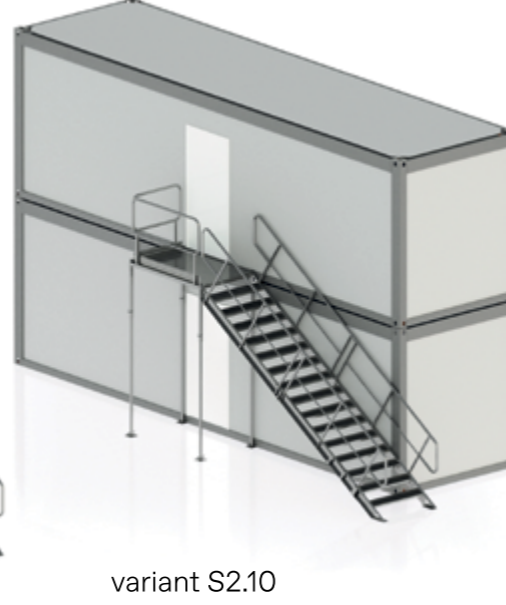

variant S2.10



variant S2.12



variant S2.13



variant S2.14

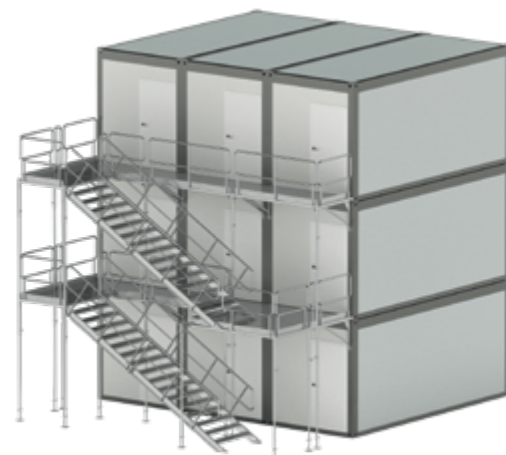

variant S2.15

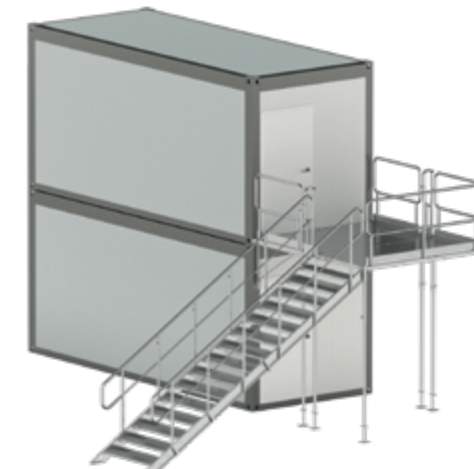

variant S2.24

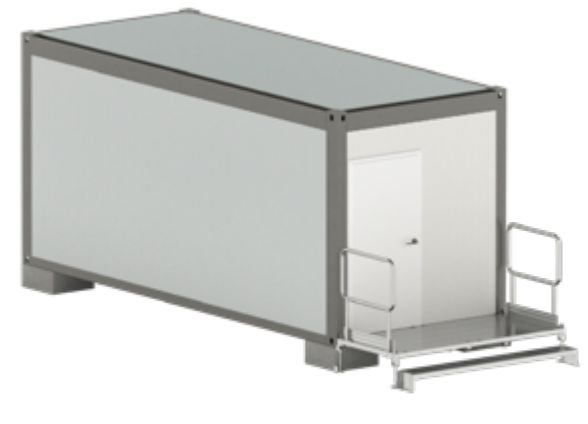

variant S2.33

Steel stairs 5kN

A type of stairs often used for containers converted into public and administrative buildings, such as kindergartens, schools, and offices.

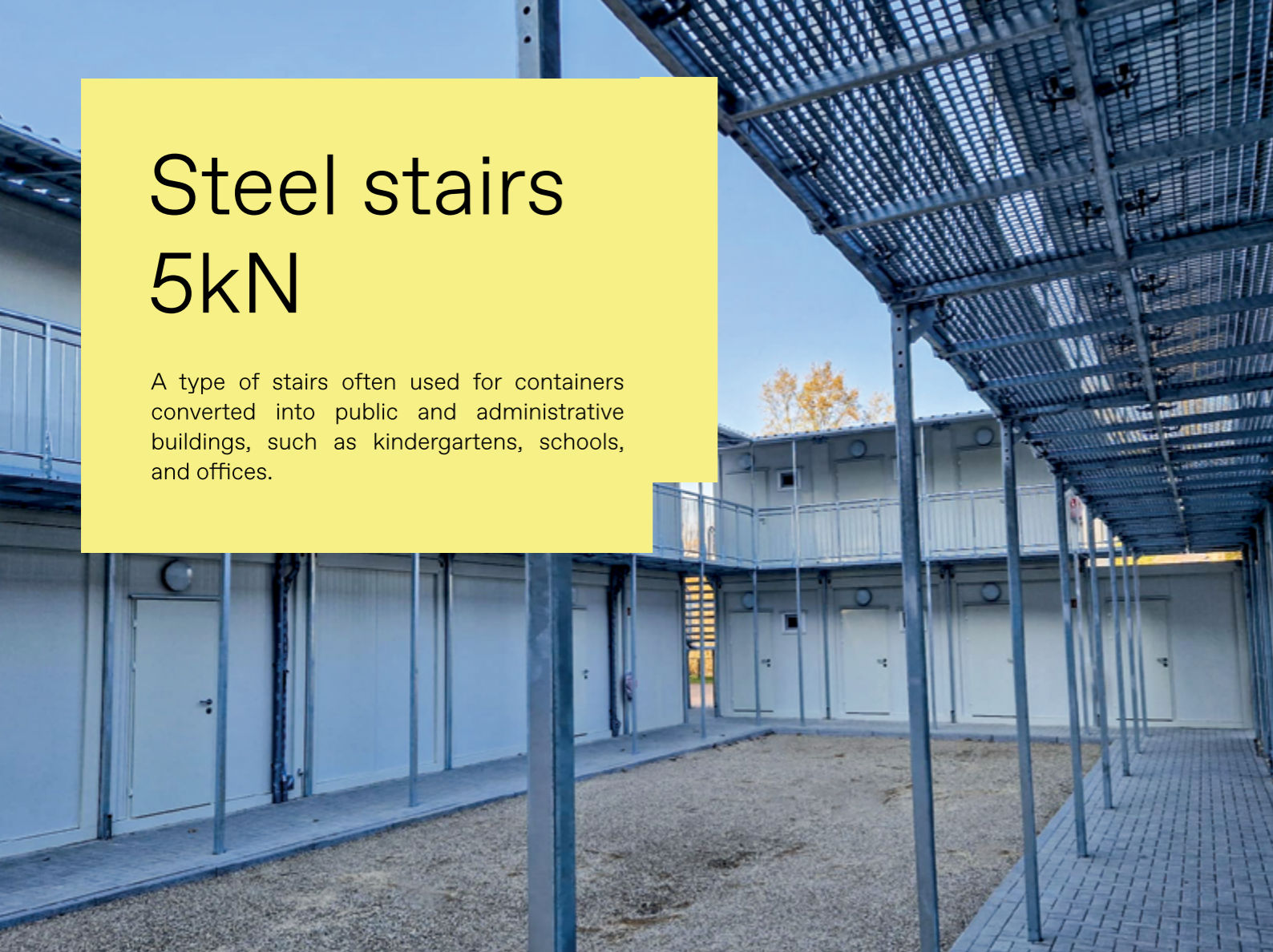

Technical details

- Steps and platforms made of press-welded gratings
- Possibility of filling the landing with serrated grating 33x11 (R11)
- One width of steps: 1250 mm
- Fast and simple assembly in any configuration
- Repeatability of elements, extension possibility
- Possibility of mounting a toeboard and additional handrails
- 5kN stairs comply with the requirements of the applicable building law

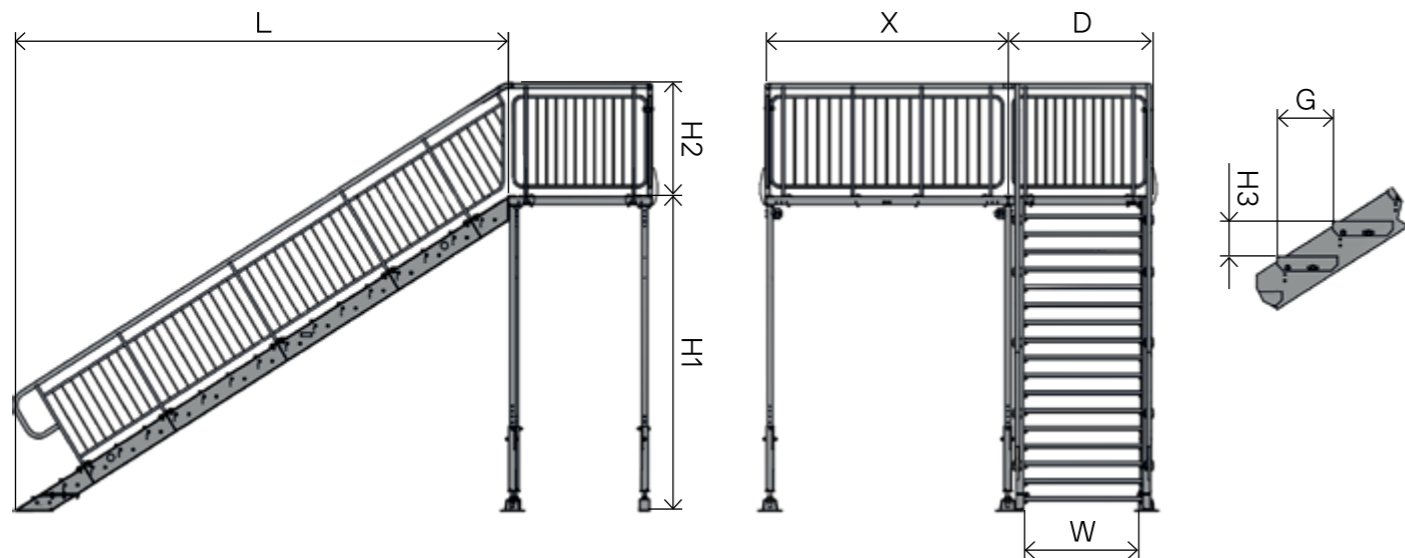
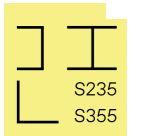
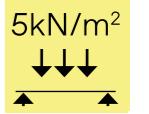

Steel stairs 5kN									
Container height [mm]	L [mm]	H1 [mm]	W [mm]	D [mm]	H2 [mm]	X [mm]	G [mm]	H3 [mm]	Number of steps
3100	5095	3265	1200	1440	1100	2440	280,4	171,8	19
2960	4974	3060							18
2800	4712	2900							17

Type of balustrade

- **Safe balustrade**

The railing is filled with additional bars according to imposed standards. They are used at areas where rigorous safety norms are in force.



Assembly variants



variant S5.1



variant S5.3



variant S5.4



variant S5.5



variant S5.8



variant S5.10

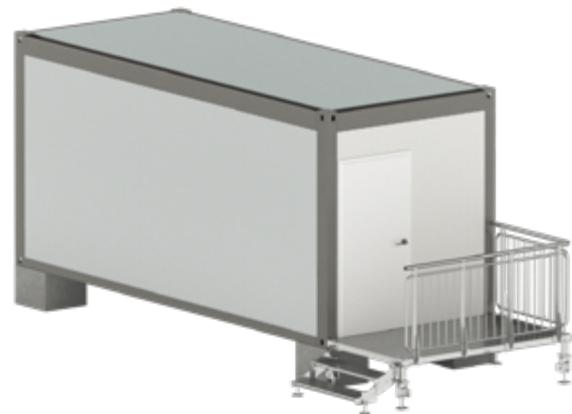

variant S5.20



variant S5.21

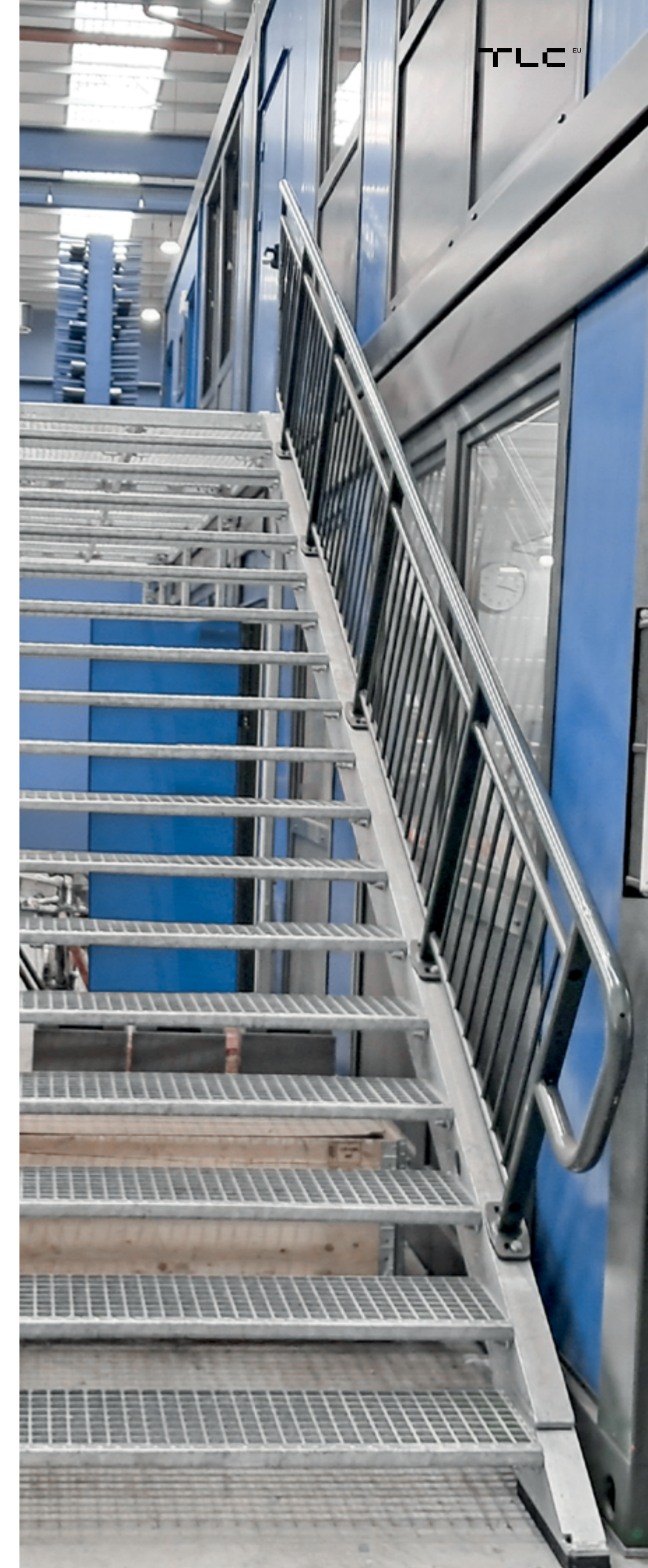

Aluminum stairs 2kN

A type of stairs often used as a temporary solution intended for rental. It is characterized by a lower weight, which can be an advantage for short-term rental or relocation.

Technical details

- Steps and platforms with non slippery surface (R12)
- Two widths of steps: 1000 and 1250 mm
- Fast and simple assembly in any configuration
- Repeatability of elements, extension possibility

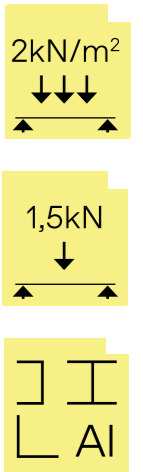

Types of balustrades

- **Industrial balustrade**

Light and simple construction that can be used whenever children safe railings are not required by law.



- **Safe balustrade**

The railing is filled with additional bars according to imposed standards. They are used at areas where rigorous safety norms are in force.

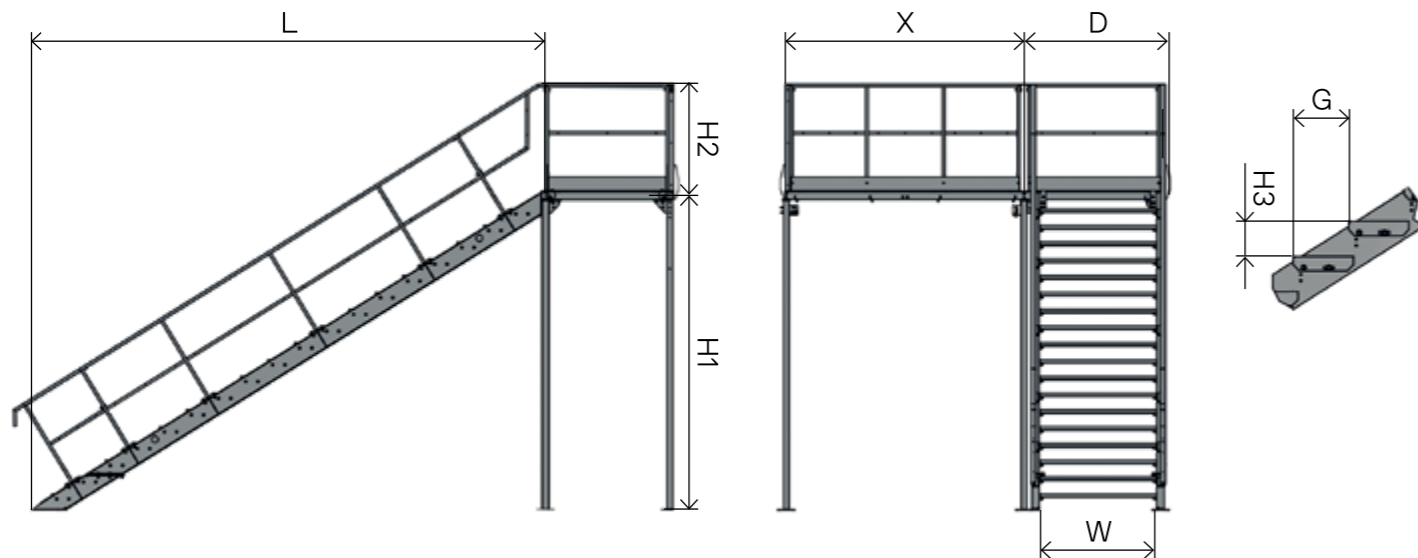

Aluminum stairs 2kN									
Container height [mm]	L [mm]	H1 [mm]	W [mm]	D [mm]	H2 [mm]	X [mm]	G [mm]	H3 [mm]	Number of steps
2960	4488	3055	1000 or 1200	1100 or 1300	1100	2440 or 3000	263	179,5	17
2800	4245	2889							16
2590	3953	2690							15

Assembly variants

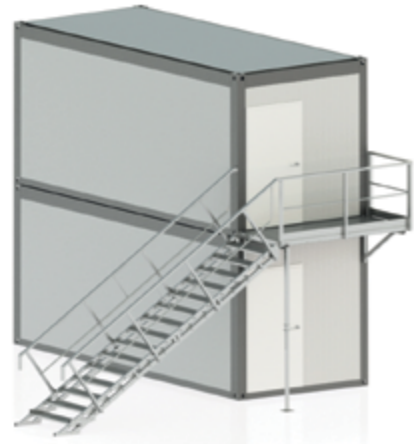

variant A2.1



variant A2.3



variant A2.4

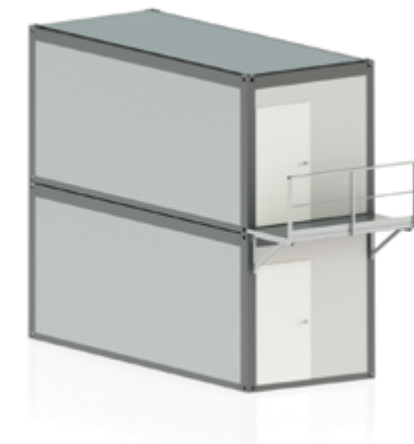

variant A2.5



variant A2.5A



variants A2.4A, A2.6

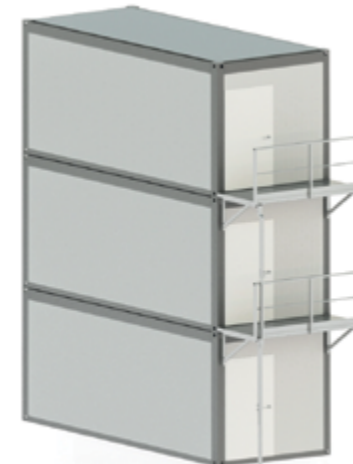

variant A2.7

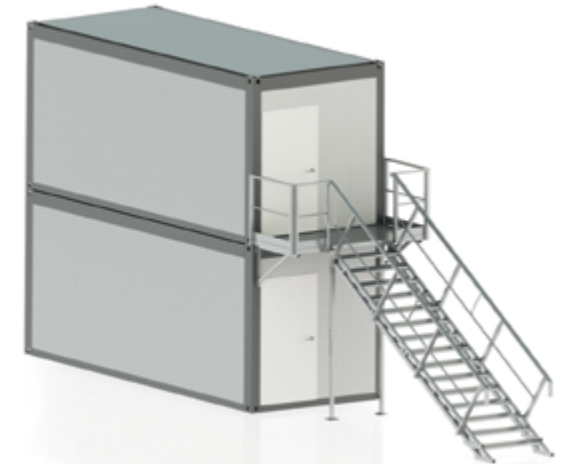

variant A2.8



variant A2.10

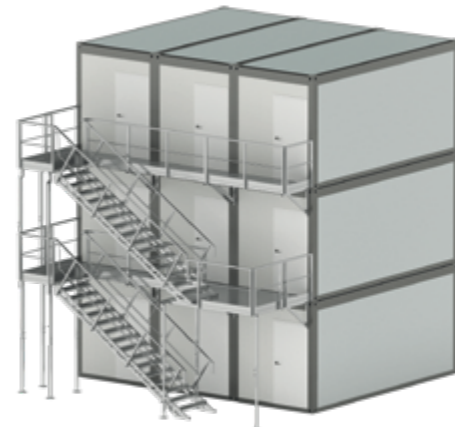

variant A2.15

Staircases

Staircases for containers are suitable for more complex infrastructures and configurations. The staircases are compatible with the TLC platform system. Corrosion protection – hot-dip galvanizing. Frames also available in RAL colors.



CONTAINER STAIRCASE P-SK-KS-2KN

A variant of external steel staircases with both safety and industrial railings. Other, non-standard staircases are also available, and it is possible to produce a staircase according to the individual needs of the customer.

Container height [mm]	Staircase width [mm]	Index
2800	1200	P-SK-KS-2.8-1.2
2590	1200	P-SK-KS-2.5-1.2
2590	1000	P-SK-KS-2.5-1.0

CONTAINER STAIRCASE P-SK-KS2

A variant of external steel staircases with an industrial railing. Available in the form of bolted modules with a standard container width of 2440 mm. Usable widths of stairs and platforms are 940 mm. Adjustable container staircase can be adapted to the heights of standard containers found on construction sites: 2591, 2800, 2960 mm.

A [mm]	2590	2800	2960
B [mm]	2705	2915	3076

Staircases

Staircases for containers are suitable for more complex infrastructures and configurations. Available in 16' and 20' container frames. The staircases are compatible with the TLC platform system.



CONTAINER STAIRCASE P-SK-KS4

A variant of internal steel staircases with safety railing. Available modules - bottom, intermediate, open (top) and closed (top) enable four configurations.



Module I
bottom



Module II
intermediate



Module III
open (top)

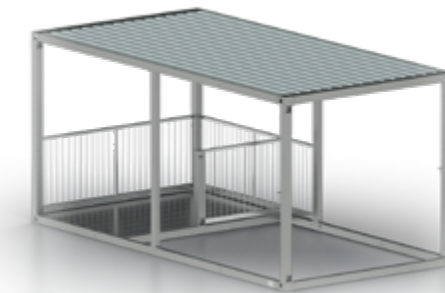

Module IV
closed (top)

5kN/m²
↓ ↓ ↓

2,0kN
↓

S235
S355

CONTAINER STAIRCASE P-SK-KS-5KN

A variant of external steel staircases with safety railing. Other, non-standard cages are also available, and it is possible to produce a cage according to the individual needs of the customer.

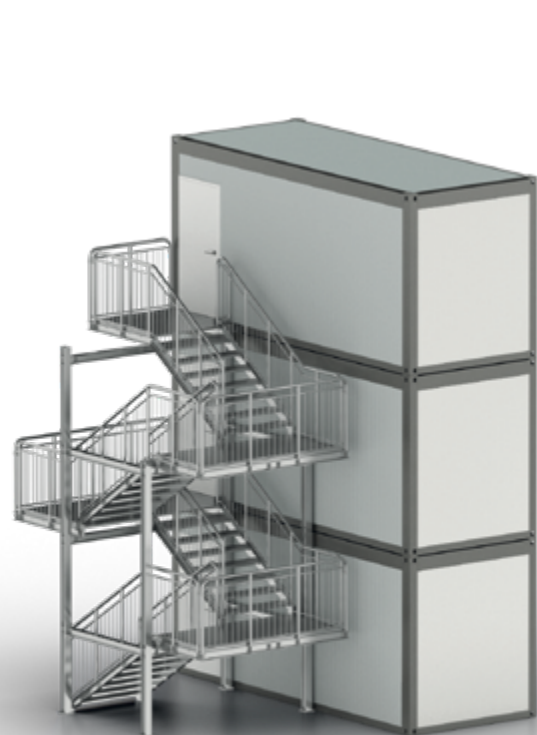

5kN/m²
↓ ↓ ↓

2,0kN
↓

S235
S355

Container height [mm]	Staircase width [mm]	Index
2800	1200	P-SK-KS-2.8-1.25
2590	1200	P-SK-KS-2.5-1.25



Configuration 1



Configuration 2



Configuration 3



Configuration 4

Configurations	CONFIGURATION 1	CONFIGURATION 2	CONFIGURATION 3	CONFIGURATION 4
Modules	I + II + III	I + II + IV	I + III	I + IV

Accessories & additional solutions



Accessories & additional solutions

ROOF AND DUST PROTECTION COVER

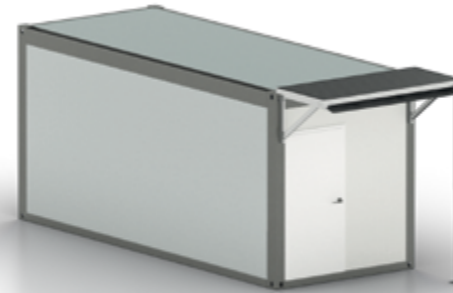

The roofing is made from a single sheet of metal. The roof is mounted on stable brackets and also serves as a dust protection cover for the lower level. Can be installed under a platform on the same brackets as platform. Available in steel and aluminum versions.

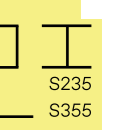
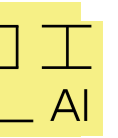

STEPS FOR WASTE TANKS

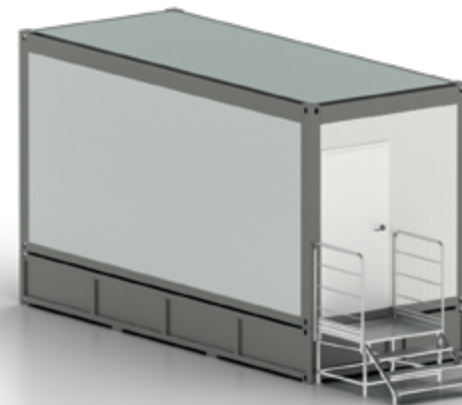

The steps provide access to waste tanks and can also be used as a service platform. The steps are filled with welded grating, and the entire structure is protected by hot-dip galvanization.

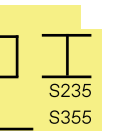

ADJUSTABLE FRAME FOR PHOTOVOLTAIC PANELS



The frame beams are adapted to standard photovoltaic panel dimensions and the feet are compatible with the roofs of standard containers. The adjustment allows for a width of 2440 or 3000 mm, with a length of 6050 mm. It can be used in single or double-pitched form.

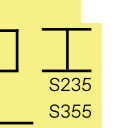

PLATFORMS FOR SHIPPING CONTAINERS



We offer platforms for shipping containers along with a system of dedicated supports and brackets. The construction of the brackets and supports allows for opening the container doors to 90°, which is essential for loading and unloading.

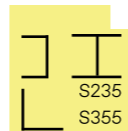

RAMPS FOR DISABLED PERSONS



The modular ramp system is characterized by ease of assembly and durability, thanks to hot-dip galvanization. The width of the movement plane on the ramp is 1300 mm, and the minimum distance between the handrails on the ramp is 1050 mm.

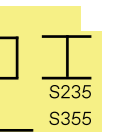

Terraces

Fillings:

- press welded grating
- perforated planks
- without surface

Railings:

- industrial balustrade
- children safe balustrade

Dimensions:

- 2440x6055 mm

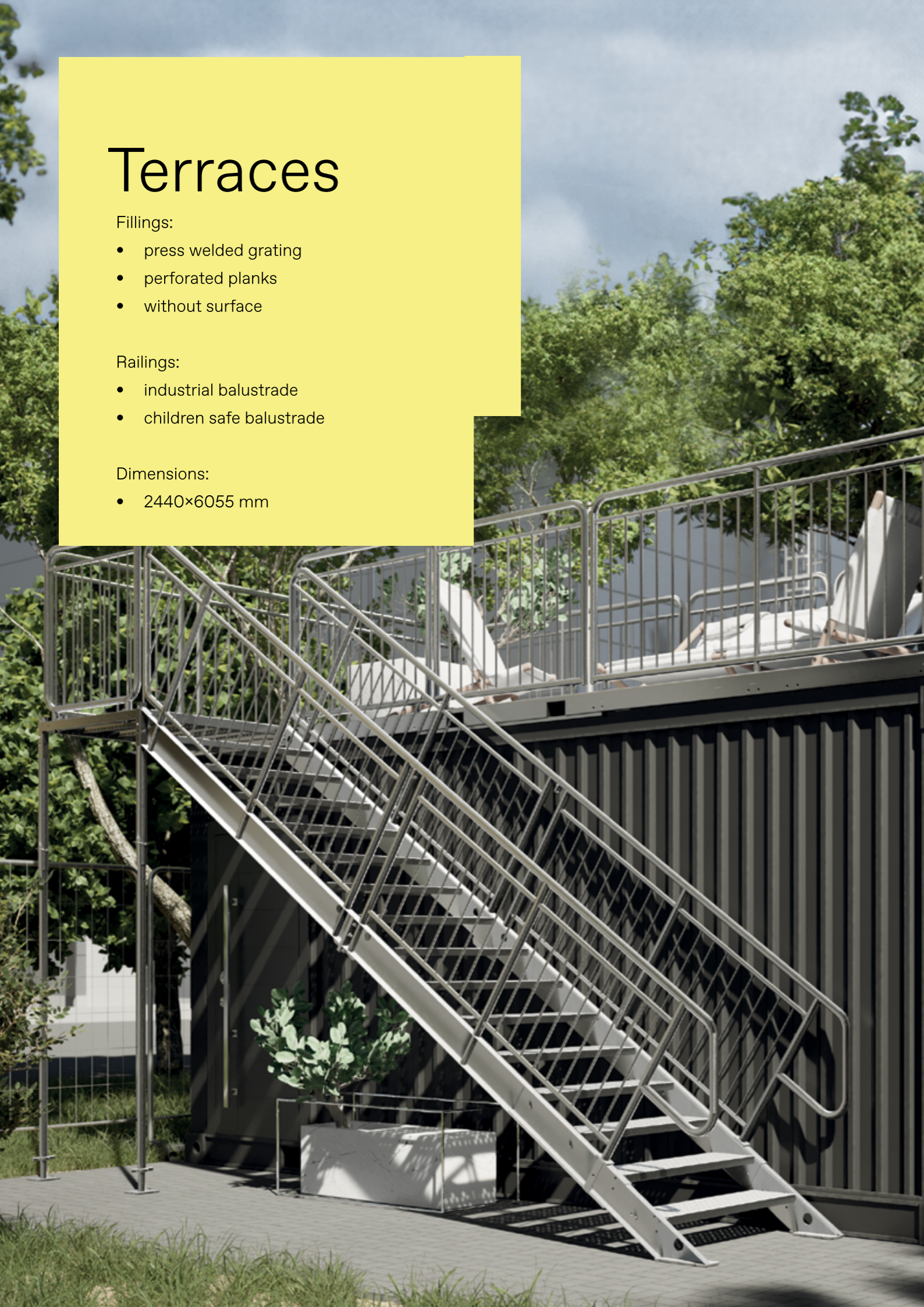

Terraces

The main purpose of container terraces is to extend the usable floor area according to individual needs of a client. Terraces can be assembled on any standard container. Choosing the right railing as well as terrace floor is usually imposed by the law. For both railing and terrace fulfillment TLC offers a standard solution or bespoke project. The entry to the terrace is possible thanks to the standard container stairs which can be assembled both inside and outside the container.



Terrace with stairs inside the container type I



Terrace with stairs inside the container type II



Terrace with stairs outside the container



Terrace with stairs outside the container in a mirrored configuration

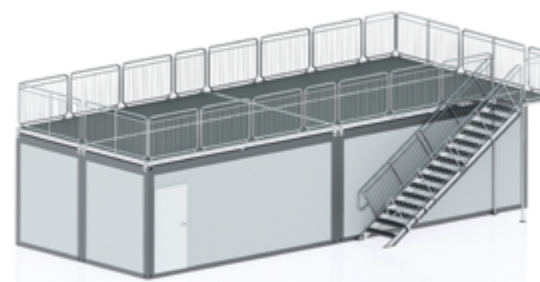

Terrace on multiple containers with stairs outside the container



Terrace with stairs on short side of the container

2kN/m²
↓ ↓ ↓

1,5kN
↓

S235
S355

Our realisations



Our realisations





Selected machines:

- Welding robots - MAG welding
- Lasers - cutting profiles, pipes and sheets
- Technological lines for galvanizing and for powder coating
- Plasma - sheets cutting
- CNC pipe bender
- CNC press brake
- Automatic Multi-spot welder for openwork



We care for life:

The above points are only a small percentage of all pro-ecological activities that have been successfully implemented **since 2018**. They result in real benefits such as:

- Competitive prices of manufactured products - **over 50% of the energy comes from the sun**
- Reduced CO2 emissions
- Reduced energy costs
- Minimized amounts of harmful waste



replacement of 100% of the car fleet by electric and hybrid



power from photovoltaic panels



automatic light system, heat pump system



electronic circulation of invoices



gadgets and marketing materials made of recycled plastics

The combination of Swedish technology and Polish entrepreneurship has allowed us to specialise in the design and production of solutions for the industrial and construction sectors.

POLAND

TLC Sp. z o.o.

+48 505 140 140
info@tlc.eu
tlc.eu

SWEDEN

Inter TLC AB

+46 70 525 99 18
info@intertlc.se
intertlc.se

GERMANY

Inter TLC GmbH

+49 5147 709 00 72
info@intertlc.de
intertlc.de

FRANCE

Inter TLC SAS

+33 (0) 744 944 644
info@intertlc.fr
intertlc.fr

We started in 2005 as a small company and today we are a group of companies with projects all over the world. The thousands of projects we have completed confirm that we are a trusted business partner. Our key customers include leading companies in the construction and industrial sectors.

We are committed to green solutions and sustainability in our operations.

Visit our website:
TLC.EU

