

Manufacturer of protection systems for construction sites

Temporary stairs, platforms, fences and barriers





We are Swedish-Polish group specialising in the design and production of solutions for the industrial and construction sectors.

We are able to predict the challenges in the next stages of construction and industrial project.

Keep calm due to our experience.

35 000+ m² of production space in three automated facilities

2005 the year we started

23 branches throughout Europe

50+ countries where our projects are located

Manufacturer, TLC Sp. z o.o., holds Enviromental Product Declaration in acc. with ISO 14025:2006 and EN 15804:2012+A2:2019/AC:2021 for industrial communication systems including stairs, railings and fencings.



TLC's production plant has implemented Factory Production Control according to EN 1090-1 and welding quality system according to PN-EN ISO 3834-2, both certified by TUV SUD Polska.

TLC's production plant has been certified with the Integrated Management System of Quality, Environment and OHS (ISO 9001/ ISO 14001/ ISO 45001) issued by Bureau Veritas Certification.



The information contained in this advertising material is provided for informational purposes only.

The product specification should be checked against the technical documentation provided by the manufacturer.

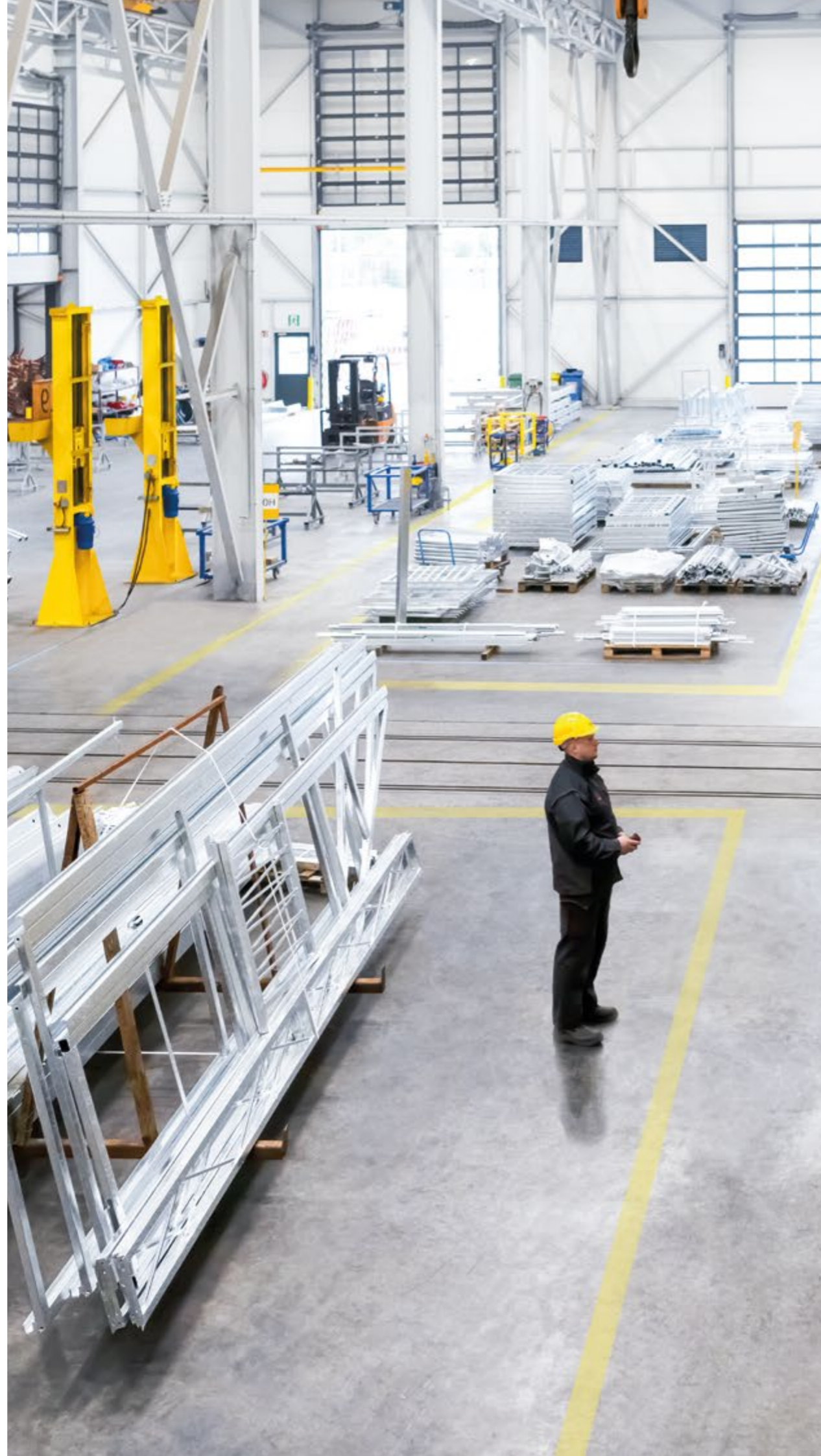

TLC	2
MOBILT temporary fence panels	4 - 5
SMART temporary hoarding fences	6 - 7
Accessories	8 - 9
CITY crowd control barriers	10 - 11
TUP crane loading platform	12 - 13
TAS temporary stairs	14 - 15
TAS temporary staircases	16 - 17
SST temporary spiral staircase	18 - 19
EPS edge protection system	20 - 21
CST Container stairs	22 - 23
Our potential	24 - 25

MOBILT

temporary fence panels

The Mobilt system consists of galvanized mesh panels, an accessories system and stabilizing feet.

It is utilized in areas undergoing construction or roadwork, where hoarding fences are unnecessary.

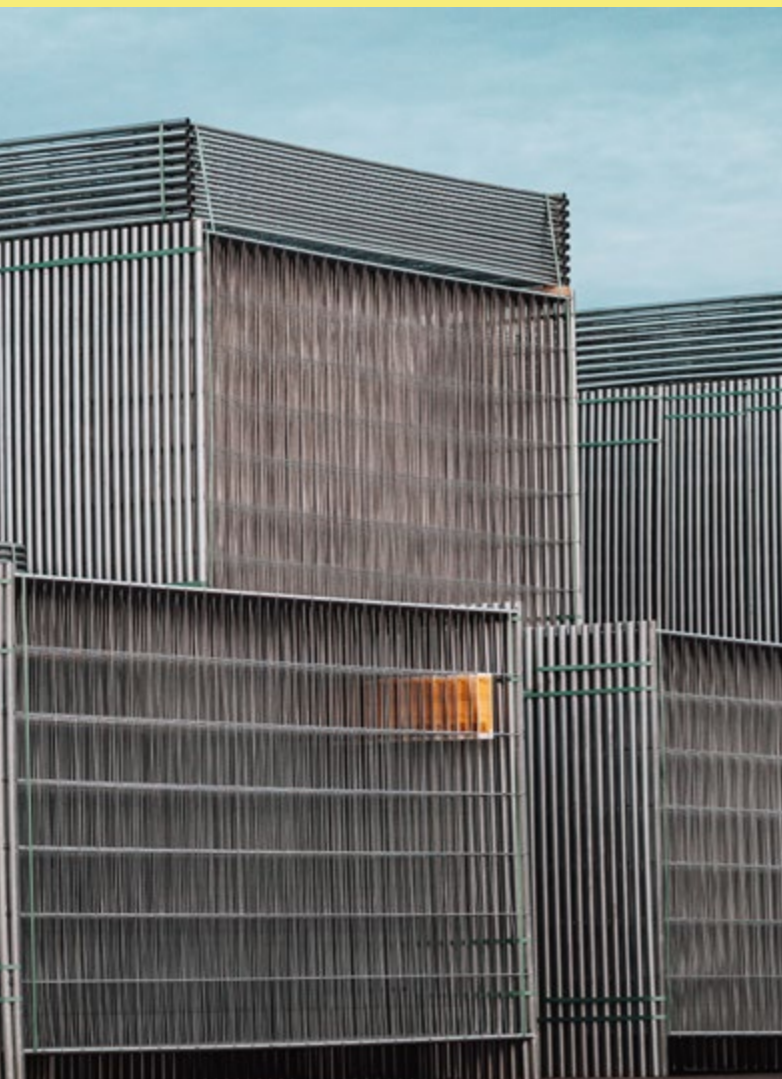

easy assembly and disassembly



RAL color coating available



a wide range of fence types and accessories



custom nameplate with your own logo available



anti-corrosion by galvanization



check out the full range of our Mobilt fences

Available heights:

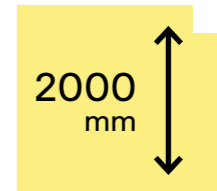

2000 mm

MOBILT Panels

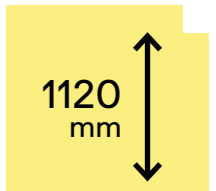

1120 mm

MOBILT Half Panels

Choosing the right MOBILT fencing variant means matching the solution to your specific site needs.

Key factors to consider include height, frame type, mesh infill, and any additional reinforcement options.

Available frames:



standard (tubes 38 × 25)



PRO (tubes 40 × 30)

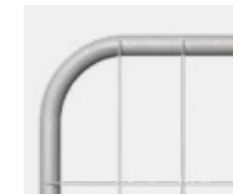

round corner RC (tube 38)

Available meshes:

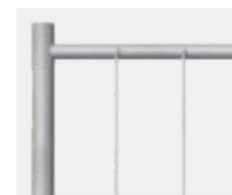

standard (120 × 250; 3,0 × 3,0)



PRO (120 × 250; 4,0 × 3,0)



anti-climb (40 × 120; 3,0 × 3,0)

Available reinforcements:



corner reinforcement CB

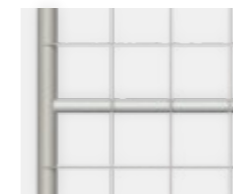

horizontal pipe S

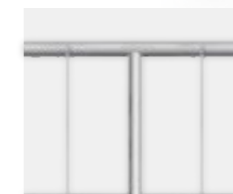

vertical pipe V



hook & eye

BEST-SELLING:

Name	Index	Dimensions [mm]	Additional reinforcement	Mesh eye [mm]	Vertical tubes [mm]	Horizontal tubes [mm]	Wire Ø [mm] Horiz/Vert	Weight [kg]*
MOBILT Panel	OT-MOB-M1	3430 × 2000	no	120 × 250	38	25	3,0 × 3,0	10,3
MOBILT PRO Panel	OT-MOB-P1	3434 × 2000	reinforced frame	120 × 250	40	30	4,0 × 3,0	14,5
MOBILT RC-CB Panel	OT-MOB-RC3	3430 × 2000	corner reinforcement	120 × 250	38	25	3,0 × 3,0	11,3
MOBILT S Panel	OT-MOB-M2	3430 × 2000	horizontal pipe	120 × 250	38	25	3,0 × 3,0	12,1
MOBILT H Panel	OT-MOB-H1	3430 × 1150	no	120 × 250	38	25	3,0 × 3,0	7,4
MOBILT H-RC Panel	OT-MOB-H3	3430 × 1120	no	120 × 250	38	25	3,0 × 3,0	8,1

*The actual weight of the products may differ from the stated value by up to 5%, as the applicable standards (e.g. EN 10305-3 for tubes, EN 10218-2 for wire, EN 10346 for sheet metal) allow specific dimensional tolerances that directly affect the weight of the final product.

SMART

temporary
hoarding fences

The Smart system is recommended for fencing construction sites and industrial areas.

Panels consist of a solid, zinc-coated steel frame filled with T18 trapezoidal sheet metal and can be powder coated in any RAL color.



easy assembly
and disassembly



RAL color coating
available



great protection of
construction sites
in the city center



custom nameplate
with your own logo
available



angle-section frame
design – replaceable
sheet panel in case of
damage



check out the full range
of our Smart fences

SMART Panel 2,8



SMART Light Panel 2,8



Name	Index	Dimensions [mm]	Frame construction [mm]	Filling	Weight [kg]*
Smart Panel 2,8	OT-S-ZN-Z	2825 × 2000	tubes 40 × 2 angle bars 60 × 40 × 2	trapezoidal T18 galvanized sheet	32,4
Smart Panel 2,8 RAL	OT-S-RAL			trapezoidal T18 RAL sheet	36,8
Smart Light Panel 2,8	OT-SL-ZN-Z	2825 × 2000	tubes 40 × 1,5 angle bars 60 × 40 × 1,5	trapezoidal T18 galvanized sheet	27,6
Smart Light Panel 2,8 RAL	OT-SL-RAL			trapezoidal T18 RAL sheet	32

SMART Light Panel 2,3

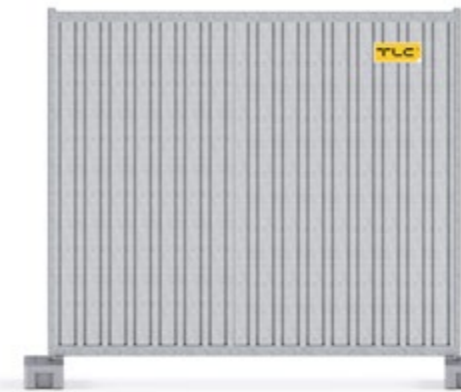

Name	Index	Dimensions [mm]	Frame construction [mm]	Filling	Weight [kg]*
Smart Light Panel 2,3	OT-S2,3-ZN	2292 × 2000	tubes 40 × 1,5 angle bars 60 × 40 × 1,5	trapezoidal T18 galvanized sheet	23
Smart Light Panel 2,3 RAL	OT-S2,3-RAL			trapezoidal T18 RAL sheet	26,6

SMART Light
Pedestrian gate 1,2
with bolt



SMART
Pedestrian gate 1,0
with bolt



SMART Light Vehicle gate 5,7 with bolt



SMART Vehicle gate 5,7 with bolt



*The actual weight of the products may differ from the stated value by up to 5%, as the applicable standards (e.g. EN 10305-3 for tubes, EN 10218-2 for wire, EN 10346 for sheet metal) allow specific dimensional tolerances that directly affect the weight of the final product.

Accessories

for MOBILT and SMART Panels

Our temporary fences systems are supported by a selection of high-quality accessories designed to improve stability, security, and user convenience.

These accessories guarantee that your fencing arrangement is not only robust but also versatile enough to adapt to different site conditions.



wide range of accessories
for every site condition



enhanced security -
anti-lift and locking
options



easy installation
and quick setup
on site



system compatibility -
fits MOBILT and
SMART panels



PVC Foot 18,5
OT-ST18,5-TLC
PVC Foot 24
OT-ST24-PVC



Concrete Foot 24
OT-ST24
Concrete Foot 32
OT-ST32
Concrete Foot 34
OT-ST34



Anti-lift Bracket HDG
OT-KL1



Coupler 3 mm
OT-KLZ

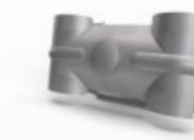

Coupler 1,7 mm
OT-KL3



Coupler 2,5 mm (low)
OT-KL4



Hinge RC HDG
OT-ZA2



Lock HDG
OT-RY7



Pin T56
OT-SZ-Z



Steel Anchor HDG
OT-KT-Z



Special Anchor HDG
OT-KT2



Wheel
OT-KO-Z



Hinge
OT-ZA-Z



Drop Bolt HDG
OT-RY



Y-shaped Barbed
Wire Bracket V1 HDG
OT-DK



Y-shaped Barbed
Wire Bracket V2 HDG
OT-DK2

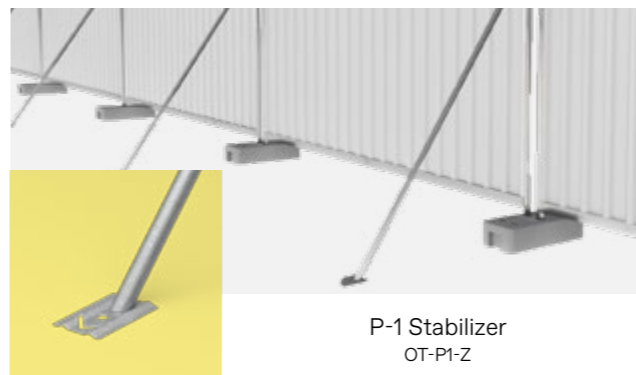

P-1 Stabilizer
OT-P1-Z

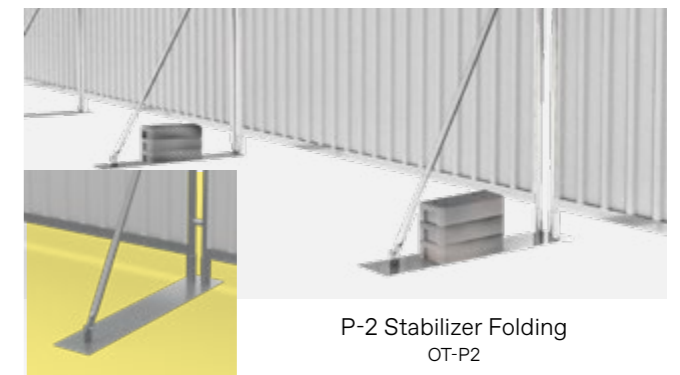

P-2 Stabilizer Folding
OT-P2

CITY

crowd control barriers

City portable barriers are designed for temporary fencing of areas during sporting events and concerts. They are used to fence off routes and temporary communication routes.



easy assembly
and disassembly



RAL color coating
available



custom nameplate
with your own logo
available



check out the full range
of our City barriers

Reflective Board
available

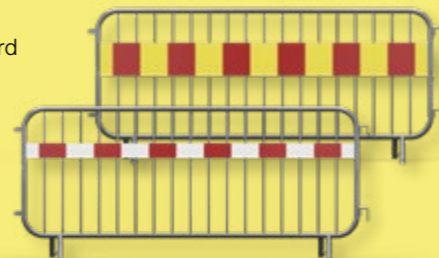

City Eco Standard Barrier 2,3



Standard feet

Name	Index	Dimensions [mm]	Corrosion protection	Design [mm]	Filling [mm]	Weight [kg]*
City Eco Standard Barrier 2,3	OT-CES	2264 × 1100	pre-galvanized steel	steel tubes 38 × 1,0	steel bars 14	10,6

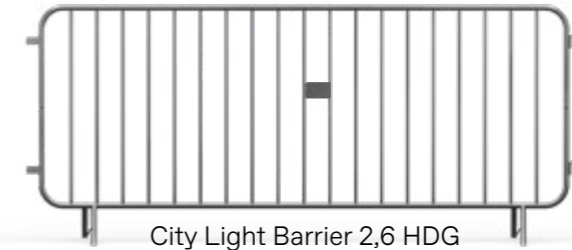

City Light Barrier 2,6 HDG



Standard feet

Name	Index	Dimensions [mm]	Corrosion protection	Design [mm]	Filling [mm]	Weight [kg]*
City Light Barrier 2,6 HDG	OT-CLG2	2600 × 1100	HDG galvanized steel	steel tubes 25 × 1,2	steel bars 14	12

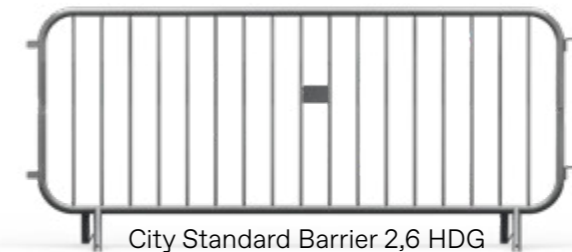

City Standard Barrier 2,6 HDG



Standard feet

Name	Index	Dimensions [mm]	Corrosion protection	Design [mm]	Filling [mm]	Weight [kg]*
City Standard Barrier 2,6 HDG	OT-CSG2	2553 × 1100	HDG galvanized steel	steel tubes 38 × 1	steel bars 14	13,4

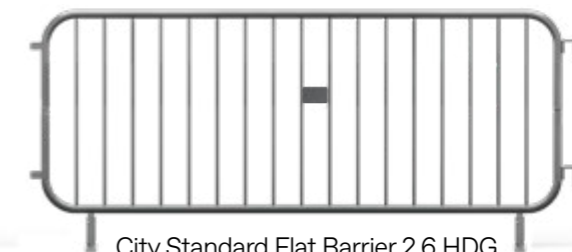

City Standard Flat Barrier 2,6 HDG



Replaceable flat foot

Name	Index	Dimensions [mm]	Corrosion protection	Design [mm]	Filling [mm]	Weight [kg]*
City Standard Flat Barrier 2,6 HDG	OT-CSW	2553 × 1100	HDG galvanized steel	steel tubes 38 × 1	steel bars 16	14,9

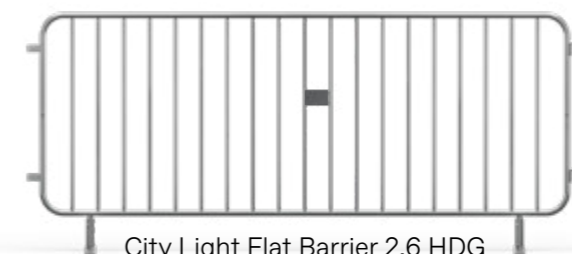

City Light Flat Barrier 2,6 HDG



Replaceable flat foot

Name	Index	Dimensions [mm]	Corrosion protection	Design [mm]	Filling [mm]	Weight [kg]*
City Light Flat Barrier 2,6 HDG	OT-CLW	2600 × 1100	HDG galvanized steel	steel tubes 25 × 1,2	steel bars 14	14,2

*The actual weight of the products may differ from the stated value by up to 5%, as the applicable standards (e.g. EN 10305-3 for tubes, EN 10218-2 for wire, EN 10346 for sheet metal) allow specific dimensional tolerances that directly affect the weight of the final product.

TUP

crane loading platform

The TUP crane loading platform is designed to enhance safety and streamline the transportation of materials to various floors within a building.

Equipped with special handles for lifting and for securing safety harnesses, the platform ensures secure handling. The ability to assemble and disassemble individual components significantly enhances the platform's mobility while reducing transportation costs.



allowed platform workload: 4000 kg



compliance with the standard: PN-EN 12811



mobility - easy assembly, disassembly, and low transport costs



3 available widths: 1.25 m, 1.5 m, 2.2 m



anti-corrosive protection through hot-dip galvanization and powder painting



enables fast transport and unloading of materials

Available assembly methods:

Between building tiers

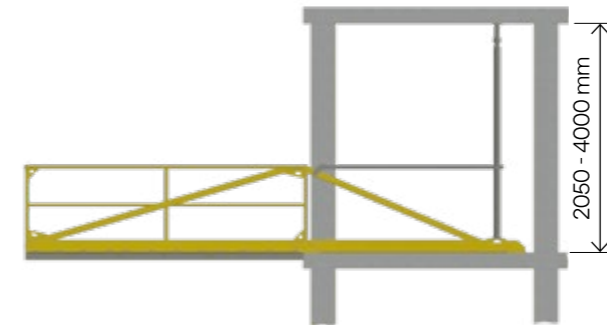

By anchoring to the slab

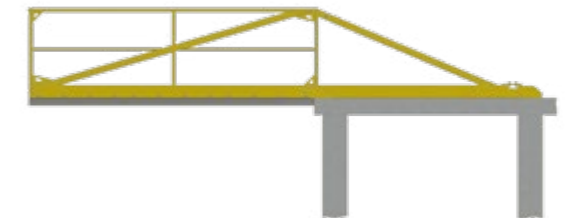

Dimensions of the platform, unloading surface and supports:

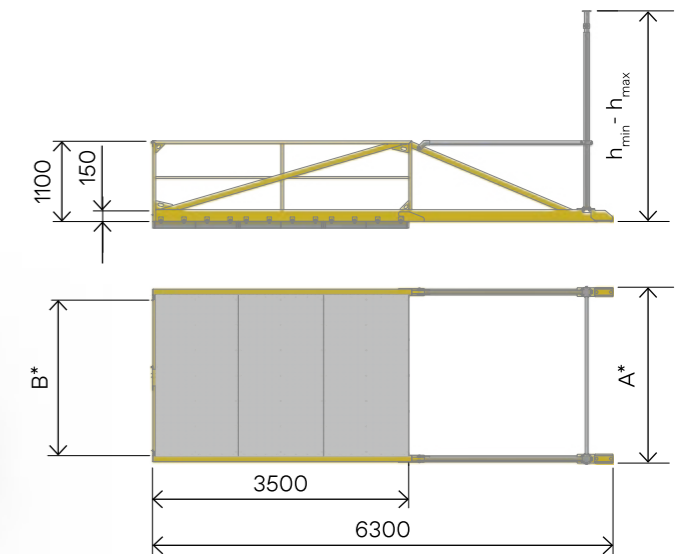

Platform frame with filling (possibility of surprinting advert)

*A and B widths for particular variants available in the table below

$h_{min} = 2800\text{mm}$, $h_{max} = 4000\text{mm}$ with support Peri PEP Ergo D-400.

Article no.	TUP-1.25	TUP-1.5	TUP-2.2
Weight [kg]	751 without supports 814 with supports	810 without supports 863 with supports	960 without supports 1013 with supports
Platform width [A]	1456	1706	2403
Unloading area width [B]	1250	1500	2200
Intended use	the platform functions as a finished solution ensuring proper unloading area for materials transported using cranes and other lifting equipment		
Materials	S235/S355 steel, aluminum	S235/S355 steel, aluminum	S235/S355 steel, aluminum

TAS

temporary stairs

The TAS system is a multifunctional structure that can be quickly and easily configured to meet various needs, serving as:

- temporary stairs for overcoming both small and significant level differences of various inclines
- temporary gangways
- step-over platforms for navigating small obstacles
- scaffolding stairs - TAS stairs equipped with special clamps enable assembly on scaffold systems



Distributed load



Point of load

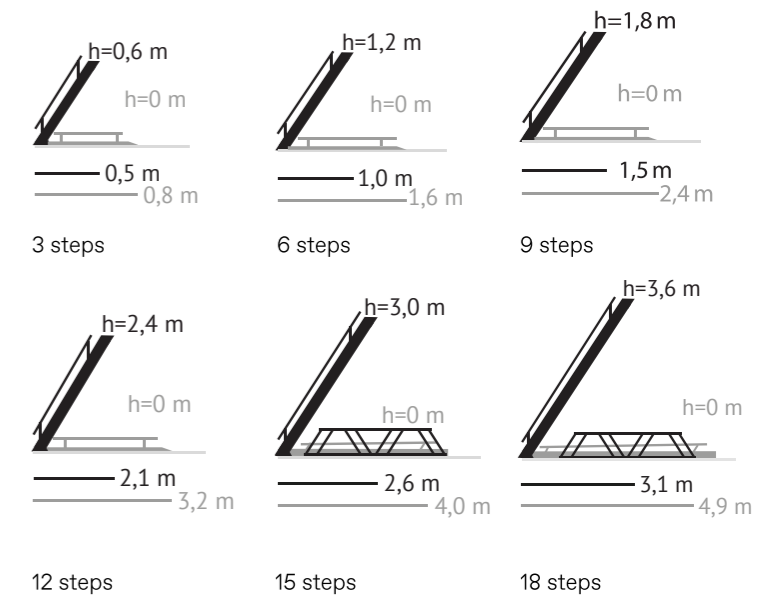
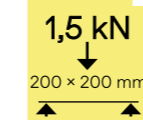

Number of steps	3		6		9		12		15		18	
Width [m]	700	1000	700	1000	700	1000	700	1000	700	1000	700	1000
Height [m]	0 - 0,6		0 - 1,2		0 - 1,8		0 - 2,4		1,6 - 3,0		2,1 - 3,6	
Weight [kg]*	47	56	74	93	105	134	133	171	162	208	192	248
Flight length [m]	0,8		1,61		2,24		3,23		4,05		4,86	
Length of stairs with guardrails [m]	1,4		2,2		3		3,8		4,6		5,4	
Max. number of users on the stairs	1		1		2		2		2		3	
Possibility to use as a gangway	no		yes		yes		yes		yes (when used with a truss)		yes (when used with a truss)	
Trench width [m]	-		1,17		1,98		2,78		3,60		4,40	

The table above shows the basic parameters of the available modules

* weight includes stairs and two guardrails

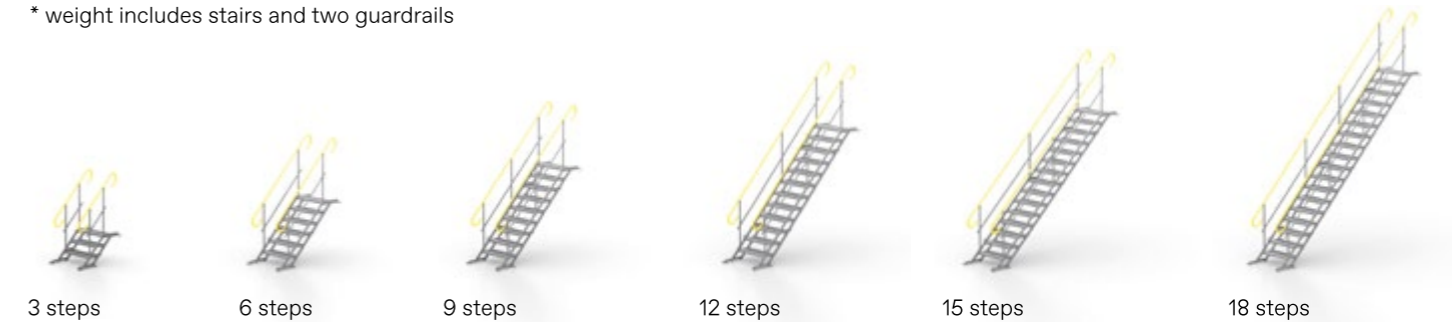

Additional elements

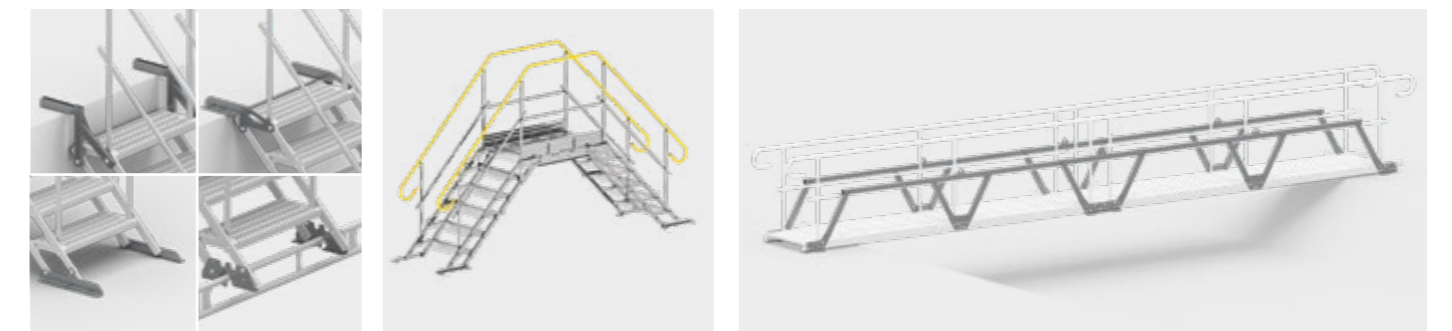

Accessories

Step-over platform

Gangway and truss



ability to create many configurations - stairs, gangways, step-over platforms etc.



compliance with the standard PN-EN 12811



anti-slip steps available in two widths: 700 and 1000 mm



easy assembly and disassembly



check out the full range of our TAS stairs

TAS

temporary staircases

Our staircases feature a modular design, offering remarkable flexibility in achieving various heights and descent directions.

The system comprises two modules: LOWER and STANDARD, along with temporary stairs.

The STANDARD module always includes a set of 12-step stairs, whereas the LOWER module allows for the selection of the appropriate number of steps based on the desired module height.



10.7m

max. height
10,7 m
(4 modules + 6 TAS steps)



compliance with
the standard
PN-EN 12811



anti-slip steps



easy assembly
and disassembly



check out the full range
of our TAS staircases

The TAS staircase descent is designed to eliminate level differences and distances between the staircase and the desired level.

The staircase features height adjustment with 7 positions (every 195 mm). To eliminate level differences and distances between the staircase and the desired level extra TAS stairs (3 or 6 steps) can be attached to the staircase exit using special adapter. By utilizing extra TAS stairs, we gain the ability to smoothly adjust the exit level.

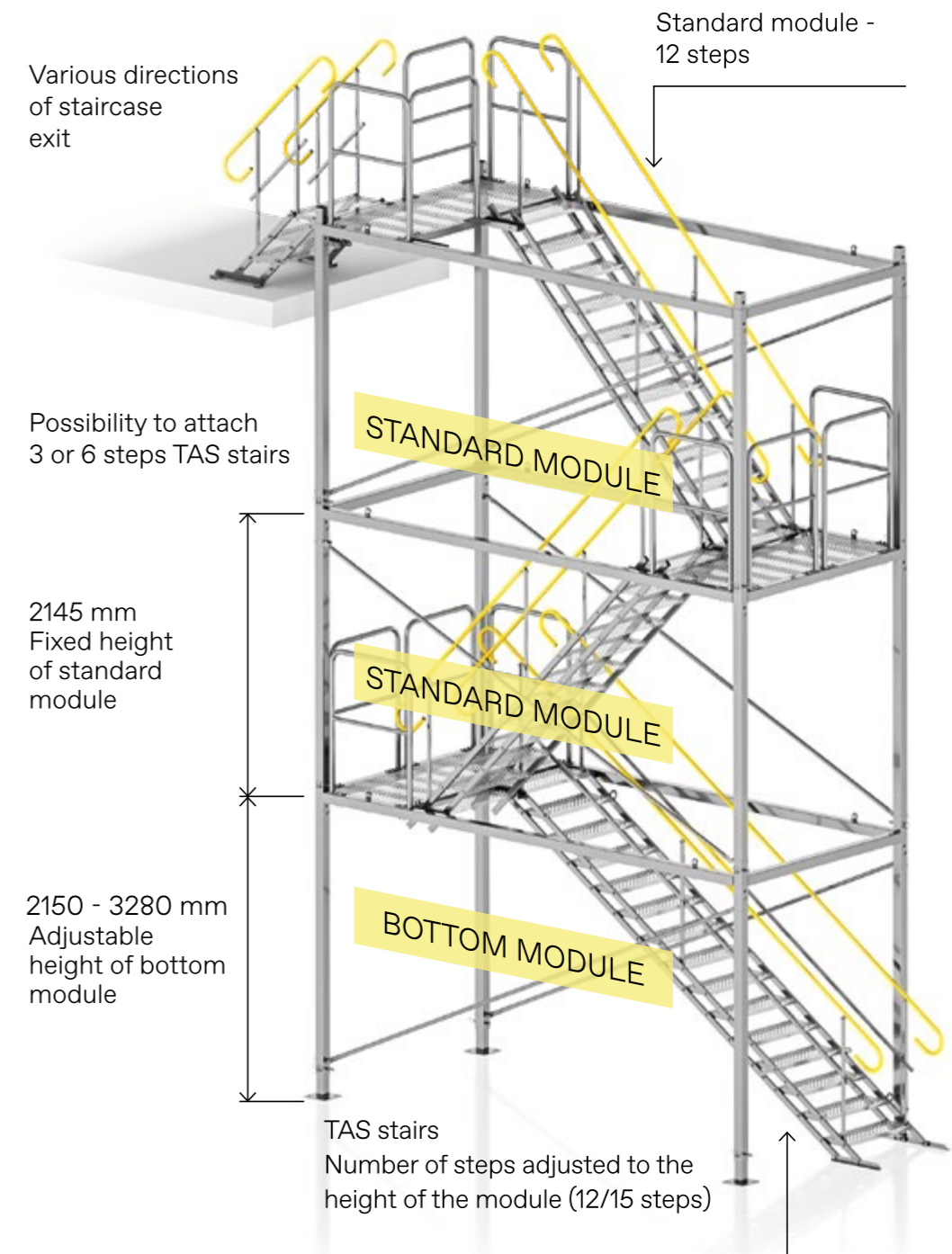

SST

temporary spiral staircase

Stairs are used on construction sites to facilitate communication between different levels.

The system comprises a base frame, intermediate module, exit step, or exit landing.

The construction is protected by hot-dip galvanization and is designed according to PN EN 12811 standard.



modular construction allowing the product customization for your needs



Possibility of compilation up to 8 modules (18440 mm)

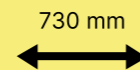

usable widths of stairs and landings – 730 mm



assembly based on screw connections



anchoring stairs to the structure using stabilizing consoles



compliance with the standard PN-EN 12811

Acceptable load unfolded



Acceptable load focused

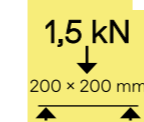

8 MODULES
18440 mm (max H)

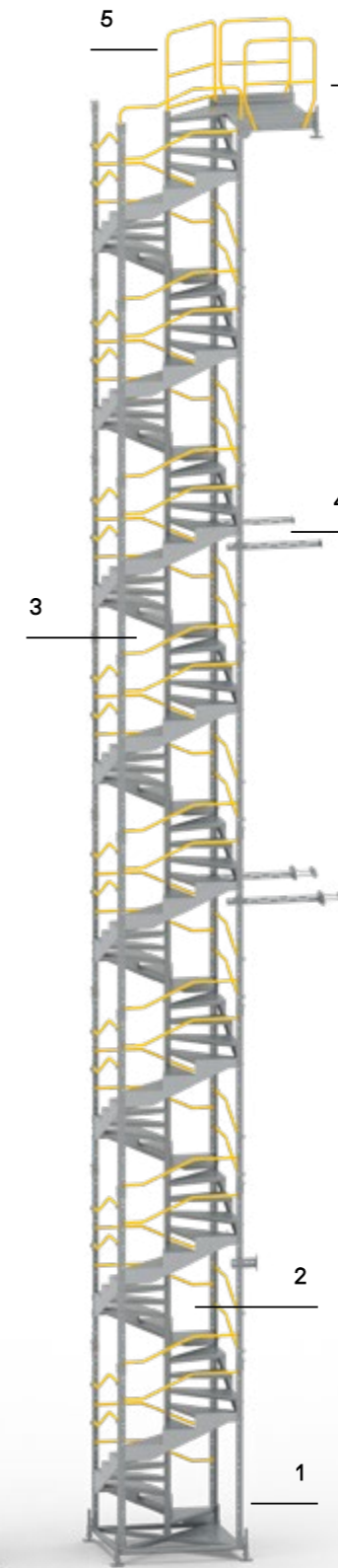

1 MODULE
2480 mm (min H)

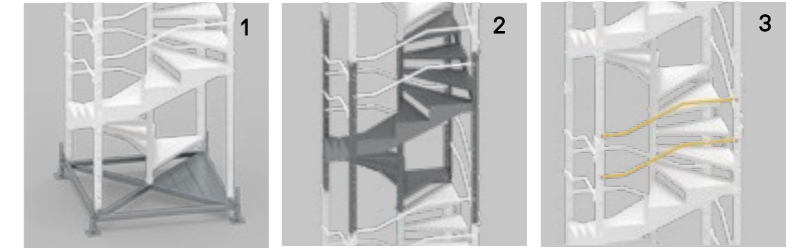

Base frame

Intermediate module (H 2280 mm)

Barrier

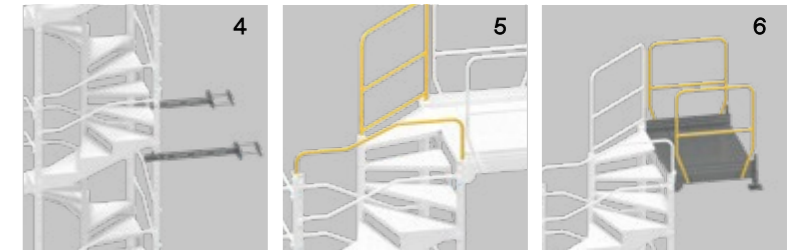

Stabilising consoles

Top module barrier

Exit landing

OPTIONAL SOLUTIONS

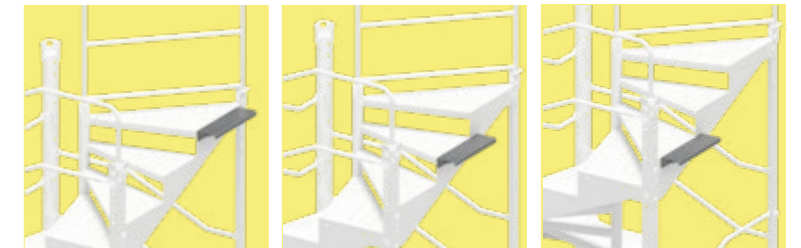

Exit step

Alternative options for mounting a exit step



Optional toe board

Optional assembly of another exit platforms



Additional level adjustment options for stair exit using TAS steps. Mounting of a platform without slab support with the possibility of lateral exit

Module	1	2	3	4	5	6	7	8
Height [mm]	2480	4760	7040	9320	11600	13880	16160	18440
Width [mm]	1600	1600	1600	1600	1600	1600	1600	1600
Weight [kg]	307	534	761	987	1214	1441	1667	1894

EPS

edge protection system

Our Edge Protection System is a contemporary fall protection system meticulously crafted to safeguard building and construction edges, technological openings (such as elevators), roof edges, passageways, and other areas prone to height-related risks.

The acronym EPS originates from Edge Protection System, encompassing a comprehensive array of safety solutions.

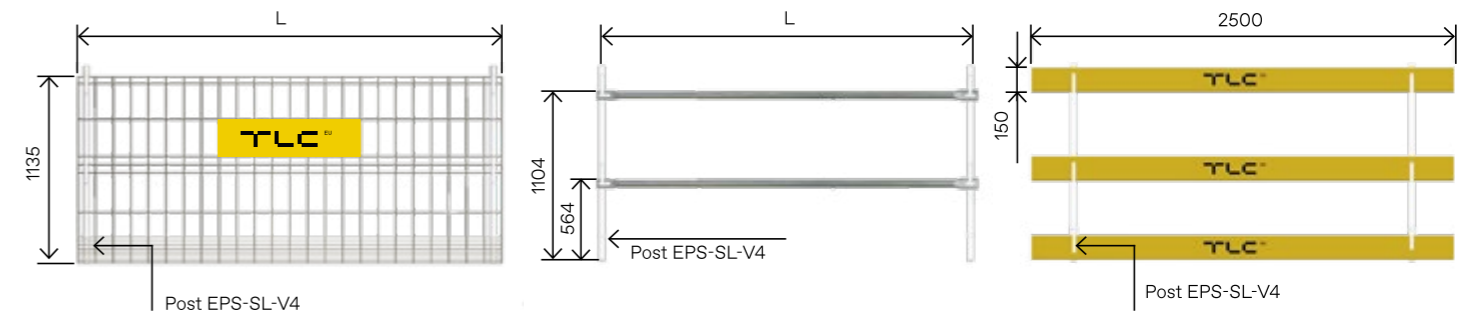

Version [mm]	2500	1250
Weight [kg]	12,4	6,2
Wire diameter [mm]	6	6
Index	EPS-PAN-ECO	EPS-PAN-ECO3-H

Version [mm]	500	700	1050	1750
Weight [kg]	1,9	2,8	5,3	8,9
Range [mm]	500-700	700-1050	1050-1750	1750-3000
Index	EPS-R500	EPS-R700	EPS-R1050	EPS-R1750

Weight [kg]	6,5
Plank thickness [mm]	32
Index	EPS-D

The full range of accessories is available on the website and upon contact with a product sales manager.



one pole compatible with all holders



wide range accessories



compliance with the standard PN EN 13374:2013



galvanized and painted powder coated panel

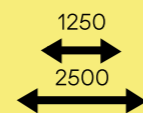

available lengths mesh panels: 1250, 2500 mm



check out the full range of our EPS system

CST

container stairs

Our stairs for containers are versatile, suitable for various types of construction containers, whether utilized for social areas, offices, warehouses, or shipping containers. Their lightweight and modular design ensures quick and easy installation.

Our stairs are designed in accordance with EN ISO 14122-3 and EN 12811-1.

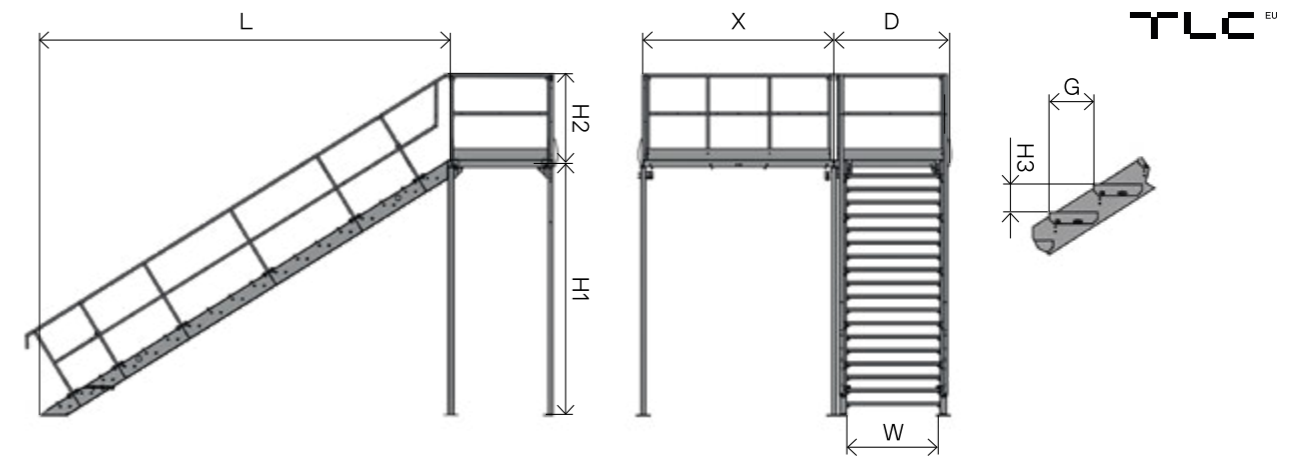

	Container height [mm]	L [mm]	H [mm]	W [mm]	D [mm]	H2 [mm]	X [mm]	G [mm]	H3 [mm]	Number of steps
Steel stairs 2 kN	2960	4594	3060	1000 or 1250	1100 or 1250	1100	2440 or 3000	270	179	17
	2800	4324	2888							16
	2590	4037	2702							15
Steel stairs 5 kN	3100	5095	3265	1200	1440	1100	2440	280,4	171,8	19
	2960	4974	3060							18
	2800	4712	2900							17
Aluminum stairs 2 kN	2960	4488	3055	1000 or 1200	1100 or 1300	1100	2440 or 3000	263	179,5	17
	2800	4245	2889							16
	2590	3953	2690							15

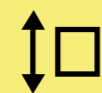

stairs adapted to container heights: 2960, 2800, 2590 mm

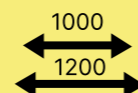

available widths: 1000, 1200 mm



compliance with standards
PN-EN ISO 14122-3,
PN-EN 12811



many configurations of steel and aluminum stairs



2kN, 5kN (steel stairs)
2kN (aluminum stairs)



check out the full range of our container stairs



Variant 1

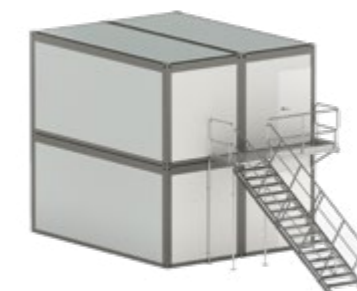

Variant 2



Variant 3



Variants 4, 4A, 6



Variant 5



Variant 5A



Variant 5B



Variant 7



Variant 8



Variant 9



Variant 10



Variant 12



Variant 13



Selected machines:

- Welding robots - MAG welding
- Lasers - cutting profiles, pipes and sheets
- Technological lines for galvanizing and for powder coating
- Plasma - sheets cutting
- CNC pipe bender
- CNC press brake
- Automatic Multi-spot welder for openwork



We care for life:

The above points are only a small percentage of all pro-ecological activities that have been successfully implemented **since 2018**. They result in real benefits such as:

- Competitive prices of manufactured products - **over 50% of the energy comes from the sun**
- Reduced CO2 emissions
- Reduced energy costs
- Minimized amounts of harmful waste



replacement of 100% of the car fleet by electric and hybrid



power from photovoltaic panels



automatic light system, heat pump system



electronic circulation of invoices



gadgets and marketing materials made of recycled plastics

The combination of Swedish technology and Polish entrepreneurship has allowed us to specialise in the design and production of solutions for the industrial and construction sectors.

POLAND

TLC Sp. z o.o.

+48 505 140 140
info@tlc.eu
tlc.eu

SWEDEN

Inter TLC AB

+46 70 525 99 18
info@intertlc.se
intertlc.se

GERMANY

Inter TLC GmbH

+49 5147 709 00 72
info@intertlc.de
intertlc.de

FRANCE

Inter TLC SAS

+33 (0) 744 944 644
info@intertlc.fr
intertlc.fr

We started in 2005 as a small company and today we are a group of companies with projects all over the world. The thousands of projects we have completed confirm that we are a trusted business partner. Our key customers include leading companies in the construction and industrial sectors.

We are committed to green solutions and sustainability in our operations.

Visit our website:
TLC.EU

